

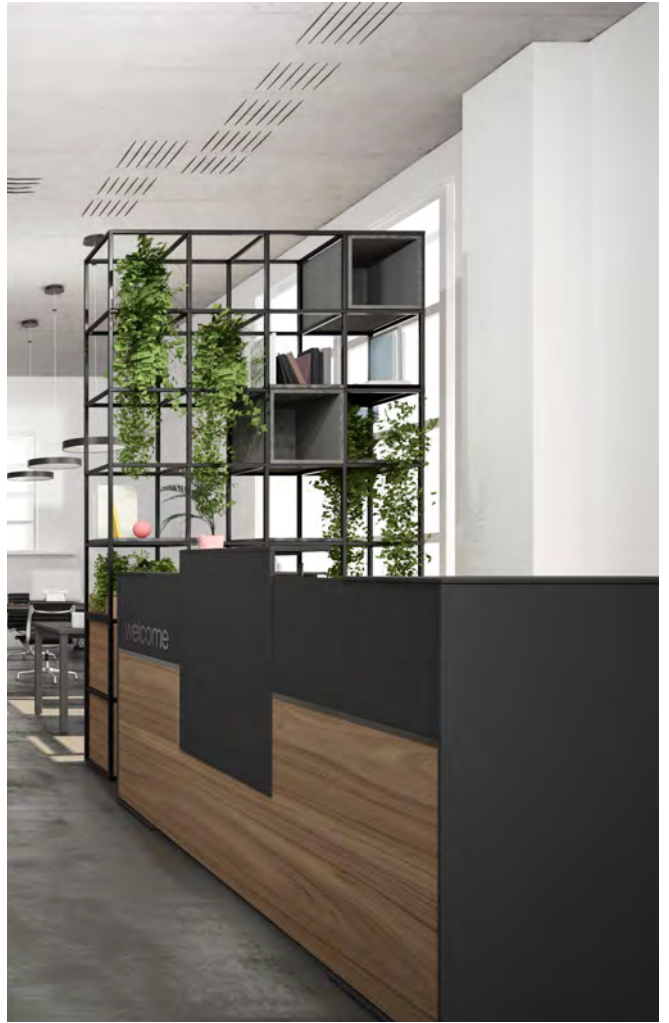

# Reception counters Nivero



## MARO Office Furniture

---

For 30 years, we have been making sure that office work is comfortable and ergonomic. Our furniture demonstrates our professionalism and love for what we do. We are passionate about creating exquisite and functional things and that translates into a quest for new solutions that turn concepts into products at a higher and higher level. Using innovative engineering solutions, we strive for ensuring that our products are top-notch. Our quality has been proved by ISO 9001 and Geprüfte Sicherheit certificates. This is possible thanks to our technology park, where world-class techniques come together under one roof. As a responsible producer, we wish to minimize our ecological footprint and expect the same from our suppliers.

Our Machinery Park guarantees top quality and precision. Thanks to the investments in new techniques and constant search for unconventional solutions, we thrive all the time. We are aware of how valuable the human factor is, therefore some elements of our furniture are hand-made. Gluing the carcasses of curved counters is a job where the human has an advantage over the machine. However, where surgical precision and repeatability in short time are necessary, we take advantage of the latest technique. Wood processing center drills, mills and processes the edges with utmost precision. The quality of our furniture is based on hundreds of trials and tests, thanks to which we are certain that we are second to none



## Reception counters Nivero

---

### TRANSPORT

- Product delivered to the customer in full.

### - WARRANTY

- 5-year MARO warranty

### CERTIFICATES



### MELAMINE PANEL BOARD CERTIFICATES



---

## Sustainable development

Find out more about our activity.



[maro.pl/firma/zrownowazony-rozwoj](http://maro.pl/firma/zrownowazony-rozwoj)

# Reception counters Nivero

Nivero reception counter is a combination of functionality and modern design. Thanks to integrated underdesk sideboards and top-mounted shelf units, it makes a well-organized work station.

The front of the counter can be in one or two colors. It is possible to add a welcome inscription made of polished steel over the decorative profile. An add-on top with LED ambient light located in the center of the counter is an additional decoration. The add-on top can also be located on the left or right side.

Nivero reception counter can be equipped with numerous accessories depending on the user's individual needs.

---

## RECEPTION COUNTER FRONT

- Chipboard coated on both sides with melamine resin with increased durability - 1st class.
- Chipboard with reduced formaldehyde emission, E1 standard.
- Board finished with 2 mm thick ABS plastic edge with 3 mm radius.
- 18 mm thick board as standard.
- Possibility to select two decors for the front as an option with no surcharge.
- Polished steel decorative profile as standard.
- Welcome inscription (H:110 mm) made of polished steel:
- Witamy/ Welcome/ Willkommen as an option with a surcharge, available for 2200 mm and 2400 mm wide counters.



## ADD-ON TOP

- Nivero reception counters are equipped with add-on tops with integrated white, cold LED ambient light as standard.
- Add-on top is located in the center of the counter as standard. It can optionally be located on the right or left.

## ADDITIONAL INFORMATION

- Colors according to MARO

## WORK TOP

- Chipboard coated on both sides with melamine resin with increased durability - 1st class.
- Chipboard with reduced formaldehyde emission, E1 standard.
- 25 mm thick work top finished with 2 mm thick ABS plastic edge with 3 mm radius.
- Top affixed to front at the height of 740 mm.
- Two round ergonomic outlets as standard.
- Monitor shelf: cut-out in the top on the right/left or in the center and shelf affixed under the top with adjustable height as an option with a surcharge.



## SIDE PANELS

- 12 mm thick side panels.
- Integrated underdesk sideboards and top-mounted shelf units on both sides on the inner part of the reception counter.



Customization on customer request.



A lockable and handy place for storing documents.



Lada Nivero

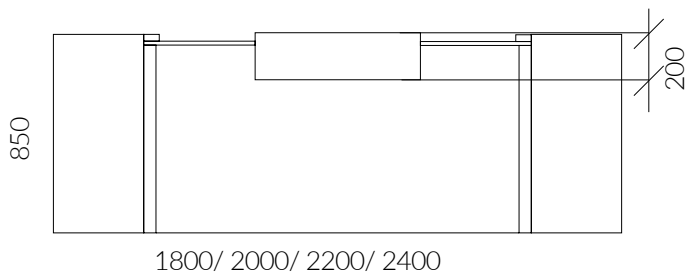
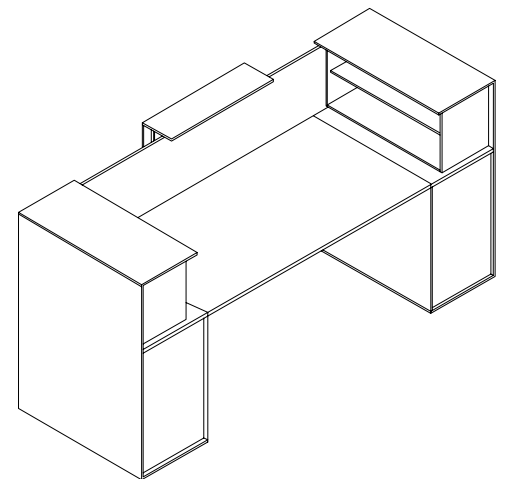
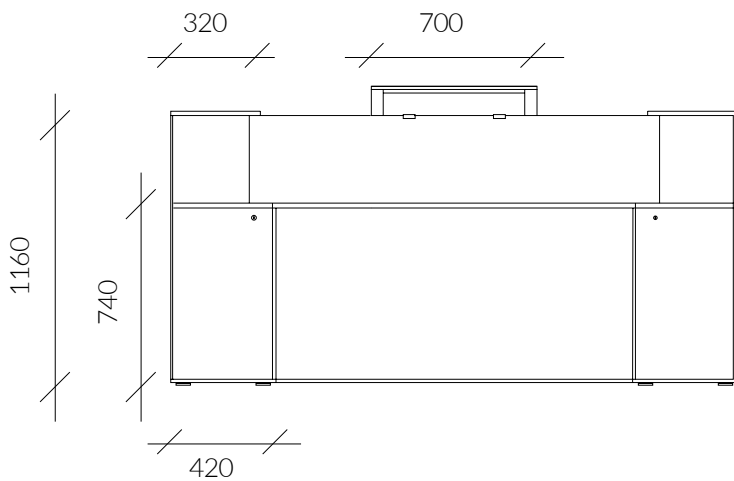
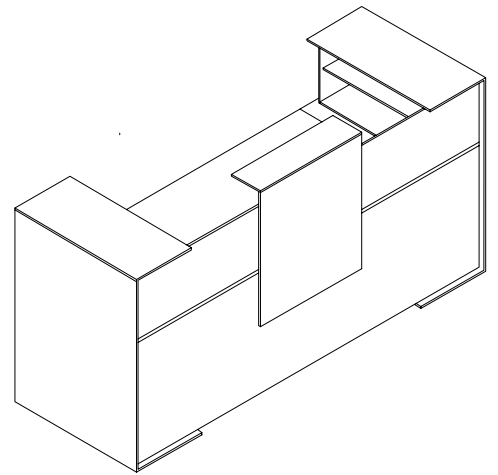
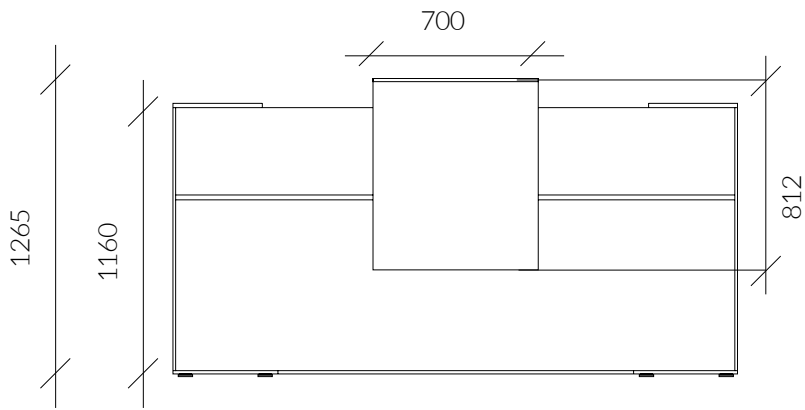

# Nivero

## Reception counter

Nivero with add-on top on the left\*

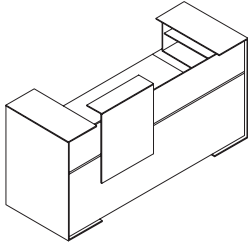

Nivero with add-on top in the center

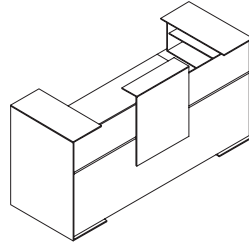

Nivero with add-on top on the right

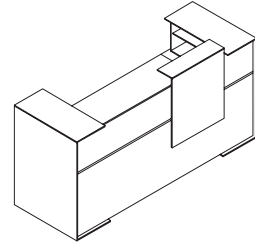

\* Looking at the front

## Nivero / Equipment

### Welcome inscription

Welcome inscription (H: 110 mm) made of polished steel: Witamy/Welcome/Willkommen on the front of the reception counter on the left or right side - as an option with a surcharge available only for 2200 mm and 2400 mm wide reception counters.

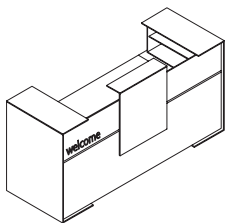

Surcharge

Price

+ 344 EUR

1. Inscription height: H: 110 mm
2. Location - right or left

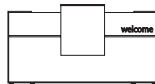
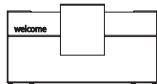

### Monitor shelf

520x200 mm cut-out in the work top located on the right or left side or in the center of the top and a shelf with adjustable height affixed under the top as an option with a surcharge. Monitor shelf excludes an ergonomic outlet.

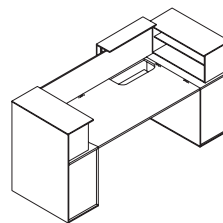

Surcharge

Price

+ 287 EUR

1. Shelf dimensions 520x200 mm
2. Location - right, left or center

### Details

Monitor shelf

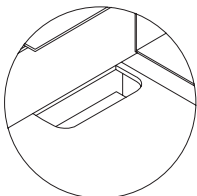

Cut-out in the work top with monitor shelf

Illuminated add-on top

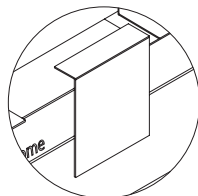

White LED ambient light

Welcome inscription

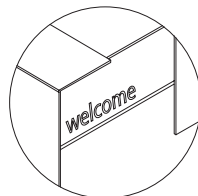

Welcome inscription made of polished steel  
Witamy/Welcome/Willkommen

Decorative profile

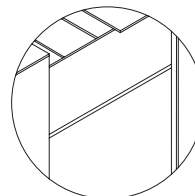

Decorative profile in brushed aluminum color

Outlet

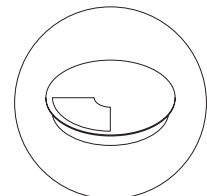

# Nivero / Accessories

## Vertical cable management

---

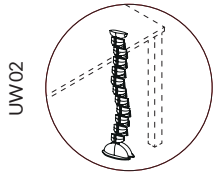

FLEXIBLE CABLE CHANNEL

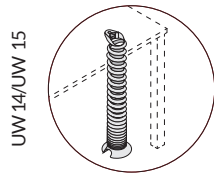

SPRING CABLE CHANNEL

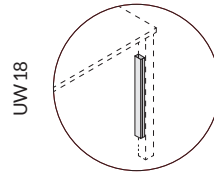

ADD-ON CABLE CHANNEL

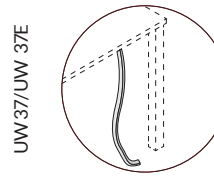

BRAIDED SLEEVE FOR CABLES

## Horizontal cable management

---

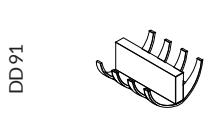

COMB CABLE CLASP

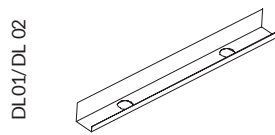

FIXED CABLE CHANNEL FOR STRAIGHT RECEPTION COUNTER

## Netboxes

---

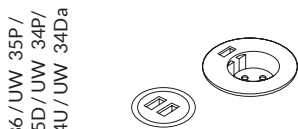

POWER CIRCLE S/M/ L

## Complementary accessories

---

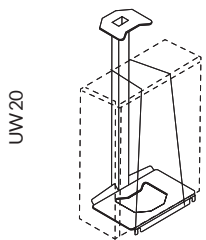

PC HOLDER

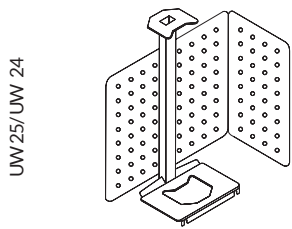

PC HOLDER WITH PERFORATED PANEL

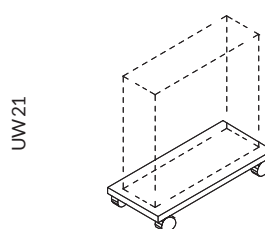

PC TROLLEY WITH CASTORS

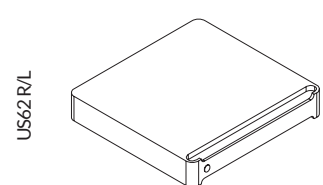

UNDERDESK DRAWER





# Melamine

① STANDARD



② TREND

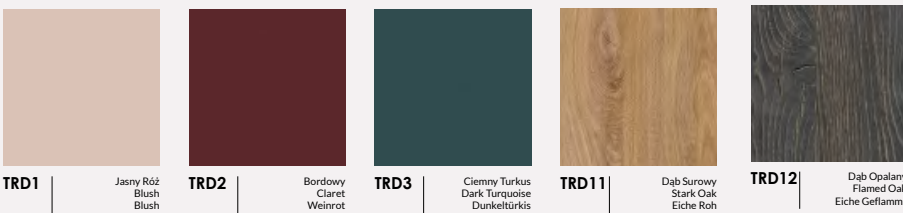

# Metal

① STANDARD

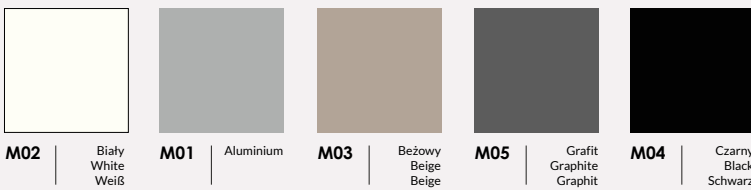

② TREND

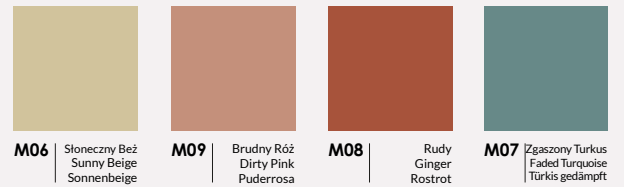

# Fabrics

100% Polyester  
100.000 Martindale cycles

① CALDO  
Select by Lech

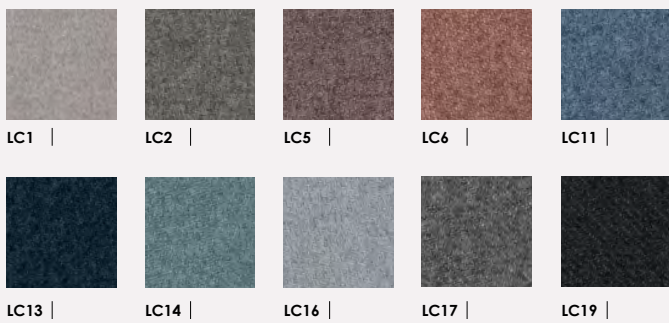

100% Recycled Polyester  
67.000 Martindale cycles

① TERRA  
Select by Lech



95% Virgin Wool, 5% Polyamid  
100.000 Martindale cycles

② SYNERGY  
Camira

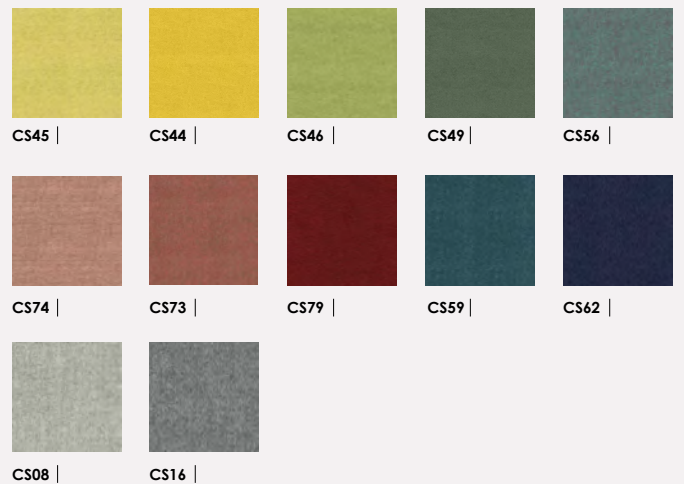

## Information

---

You can find all our current materials online.

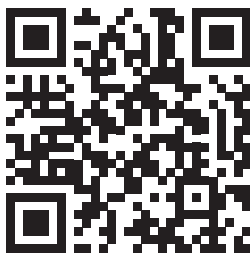

Visit our website [maro.pl](http://maro.pl)

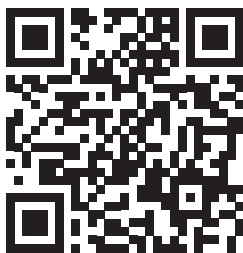

Find high quality photos and films to use in your materials  
[maro.cloud/photo](http://maro.cloud/photo)



Find solids and catalogs  
[maro.pl/design-tools/pliki-do-pobrania](http://maro.pl/design-tools/pliki-do-pobrania)



Order furniture online  
[shop.maro.pl](http://shop.maro.pl)



Fabryka Mebli Biurowych MARO Sp. z o. o.  
PL 62-052 Komorniki, ul. Fabianowska 100

+48 61 890 00 00

[maro@maro.pl](mailto:maro@maro.pl)

[MARO.pl](http://MARO.pl)

## Follow us and join t o MARO community

 /@maroofficefurniture

 /@maroofficefurniture

 /@maroofficefurniture

 /@maroofficefurniture

Please place your orders for printed materials and color samples by e-mail to [marketing@maro.pl](mailto:marketing@maro.pl).

Illustrations presented in this publication are only illustrative and do not constitute any offer or guarantee of any form - it especially applies to presented color and furniture surfaces used by MARO Office Furniture Factory. Please contact MARO sp. z o. o. to obtain information on functions and configurations.

All presented data, especially photos, specifications, descriptions, drawings and technical parameters do not constitute an offer in legal terms of the Civil Code, are not binding and can be changed without prior notice. A Sales Contract contains bidding prices, equipment and specifications.

We reserve the right to make changes and mistakes. All the information in this price list is up-to-date on the publication date/accepting the material for publishing. The prices do not include VAT tax.

General Terms and Conditions of Sales and General Warranty and Complaint Terms and Conditions constitute an integral part of Sales Contracts.

The price list is valid from 01.07.2022 until further notice.