

SISTEMI

DESKS

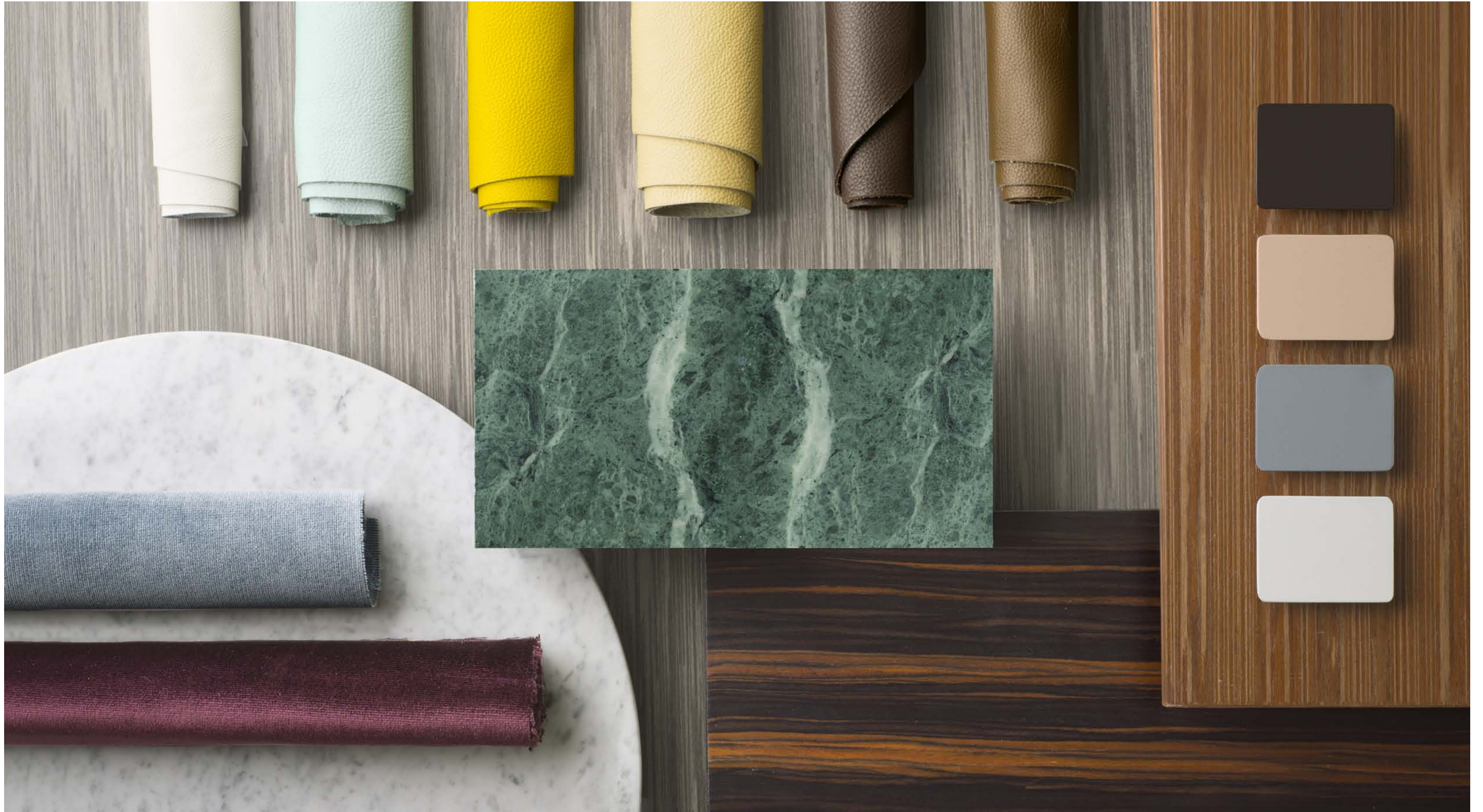

vivax IRODABÚTOR



**ROGER
ARCHITETTO
ROBERTO
BACIOCCHI**

Una collezione di tavoli protagonisti in ogni spazio, affascinanti nella loro semplicità, versatili nelle dimensioni e nell'utilizzo. La personalità unica, nasce dall'essenzialità della struttura realizzata con gambe metalliche a "L" e piani di elevato spessore disponibili in essenza o rivestiti in pelle. Gli spigoli sagomati per l'inserimento delle gambe donano ai piani un aspetto moderno e ricercato. Roger adotta i sistemi di librerie Bookcase e Shelve oltre ai complementi per tavoli.

A collection of tables protagonists in every space, fascinating in their simplicity, versatile in size and use. The unique personality is born from the essentiality of the structure made with metal legs with "L" shape and high-level tops available both veneered or upholstered in leather. The shaped edges for the insertion of the legs give to the tops a modern and refined look. "Roger" adopts "Bookcase" and "Shelve" compositions as well as table complements.



Scrivania 225x100, piani in essenza Piacava, gambe finitura Cipria. Troller di servizio con top, fianchi e cassetto in essenza Piacava, anta in pelle Ice 353. Poltrona HyWay in pelle Ice 353. Libreria Shelve finitura Cipria. | Desk 225x100, tops veneered in Piacava, legs in Powder Pink finish. Troller with tops, sides and drawer in Piacava veneer, door in Ice leather 353. HyWay armchair in Ice leather 353. Shelve bookshelve in Powder Pink finish. | Bureau 225x100, plateau en finition bois Piacava, pieds finition Poudre. Troller de service avec plateau, côtés et tiroir en finition bois Piacava, porte en cuir Ice 353. Fauteuil HyWay en cuir Ice 353. Bibliothèque Shelve avec finition Poudre.

ROGER COLLECTION





ROGER COLLECTION



ROGER COLLECTION

Scrivania 225x100 piano in pelle Ice 353, gambe e cassetiera finitura Marrone Maserati. Poltrona Amelie in Pied Poule F963.01, braccioli in pelle Nocciola 306. Libreria Shelve marrone Maserati. | Desk 225x100 cm, upholstered top in Ice leather 353, legs and drawer unit in Brown Maserati finish. Amelie armchair in Pied Poule F963.01, armrests in Hazel leather 306. Shelve bookshelve in Brown Maserati finish. | Bureau 225x100 cm plateau revetu en cuir Ice 353, pieds et tiroir en finition marron Maserati. Fauteuil Amélie en Pied Poule F963.01, accoudoirs en cuir Nocciola 306. Bibliothèque Shelve marron Maserati.





ROGER COLLECTION

Scrivania 225x100 piano in pelle Ice 353, gambe finitura Marrone Maserati con inserti in pelle Nocciola 306. Tavolo riunione 150x150 piano in essenza Ebano, gambe finitura Gesso. | Desk 225x100 cm, upholstered top in Ice leather 353, legs in Brown Maserati finish with Hazel leather 306 inserts. Meeting table 150x150, top in Ebony veneer, legs in Chalk finish. | Bureau 225x100 cm en cuir Ice 353, pieds finition marron Maserati avec inserts en cuir Nocciola 306. Table de réunion 150x150 plateau en finition bois d'ébène, pieds finition Platre.



Mobile Bookcase 93x135H, base metallica Babila e maniglie finitura marrone Maserati. Top, fianchi e ante in pelle Ice 353. | Bookcase 93x135H, with Babila metal base and handles in Brown Maserati finish. Top, sides and doors in Ice leather 353. | Bibliothèque 93x135H, base structure en métal Babila et poignées en finition marron Maserati. Plateau, côtés et portes en cuir Ice 353.



ROGER COLLECTION



ROGER COLLECTION



Tavolo riunione 150x150 piano in essenza Ebano, gambe finitura Gesso, inserto in pelle Carioca 333. Mobile Bookcase 93x100, base metallica Babila e maniglia in finitura oro, ante in essenza Ebano, top e fianchi in pelle Ghiaccio 301. Meeting table 150x150, top in Ebony veneer, legs in Chalk finish, insert in Carioca leather 333. Bookcase 93x100, with Babila metal base and handle in gold finish, doors in Ebony veneer, top and sides in Ice leather 301. Table de réunion 150x150 plateau en finition bois d'ébène, pieds finition Platre, insert en cuir Carioca 333. Bibliothèque 93x100, structure base Babila et poignée en finition dorée, portes en finition bois d'ébène, plateau et côtés en cuir Ghiaccio 301.

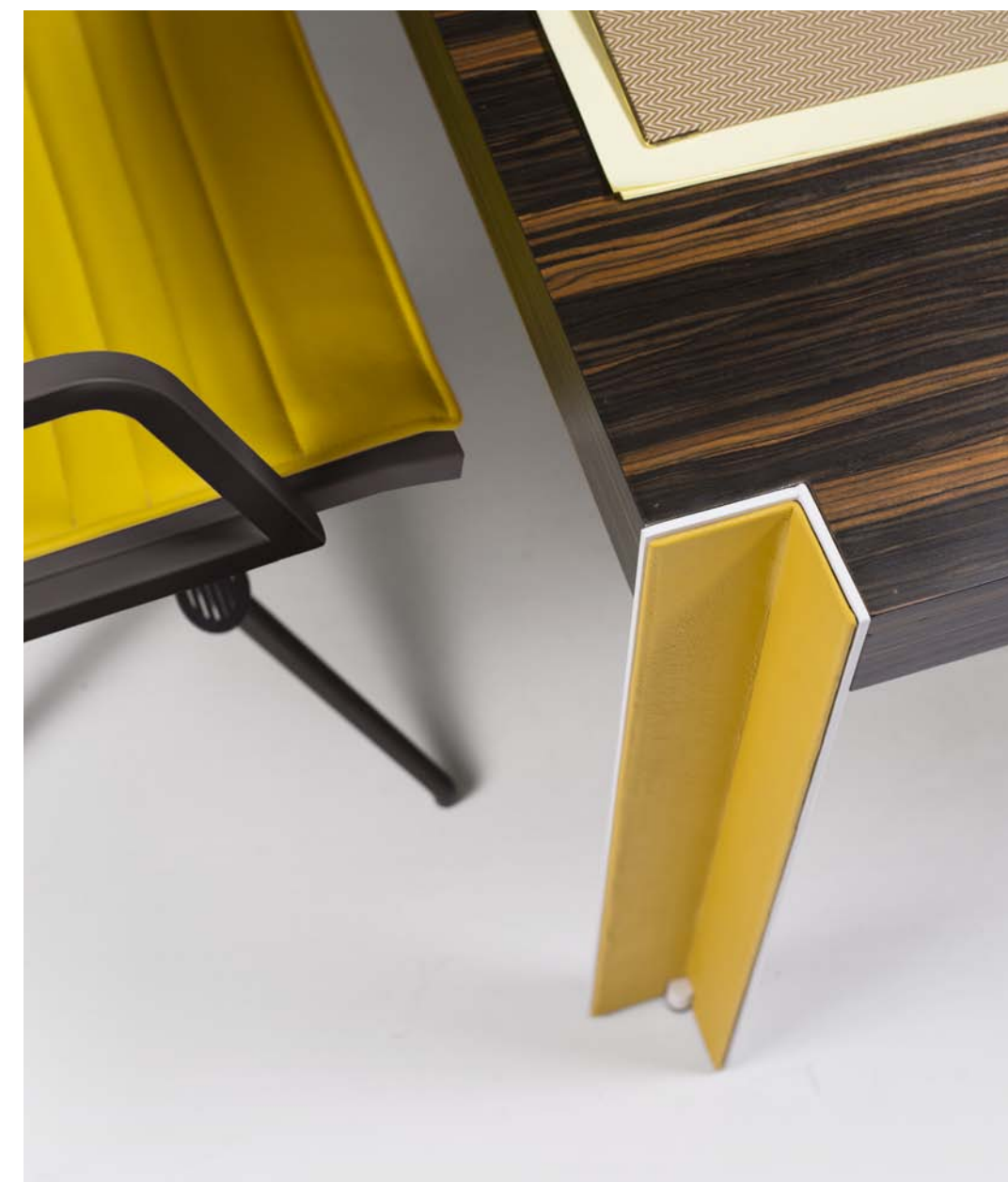

ROGER COLLECTION

Tavolo riunione 300x100 piano in essenza Ebano, gambe finitura Gesso, Poltrone Word in pelle Carioca 333, struttura marrone Maserati. Libreria Shelve finitura Gesso. | Meeting table 300x100, top in Ebony veneer, legs in Chalk finish, Word armchairs in Carioca leather 333, Brown Maserati structure. Shelve bookshelve with Chalk finish. | Table de réunion 300x100 plateau en finition bois d'ébène, pieds finition Platre, fauteuils Word en cuir Carioca 333, structure marron Maserati. Bibliothèque Shelve en finition Platre.



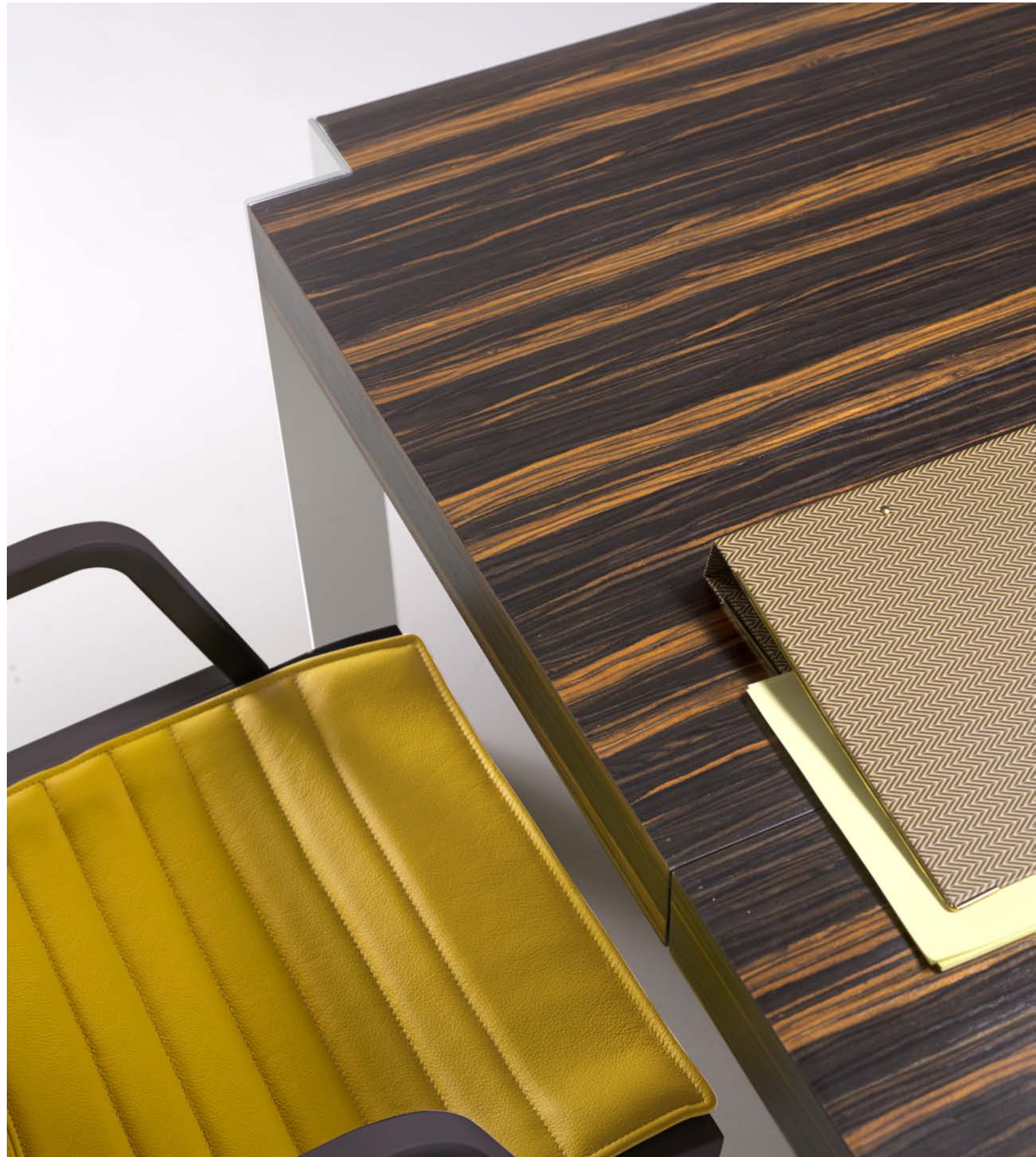

ROGER COLLECTION

Gamba in acciaio dalla originale forma a "L" dotata di piedino livellatore. Disponibile anche in versione rivestita. Steel leg with an original "L" shape equipped with a leveling foot. Also available in upholstered insert version. Pied en acier avec la forme originale de "L" équipée d'un pied de nivellement. Aussi disponible en version avec insert revêtu.

Vertebra verticale passacavi innovativa nel design e nei materiali. Si fissa al piano ed è posizionabile liberamente. Vertical cable holder innovative in design and materials. It is fixed to the top and can be positioned freely. Vertèbre recueillies câbles innovantes dans le design et les matériaux. Il est fixé au plateau et peut être positionné librement.

Passacavi e sistemi di cablaggio da integrare al piano scrivania. e posizionabili liberamente. Tray for cable collection to be fixed to the top. It allows the passage of wiring as well as containing multi-sockets. Goulottes porte-câbles à fixer au plateau. Il permet le passage des systèmes ainsi que des prises multiples.

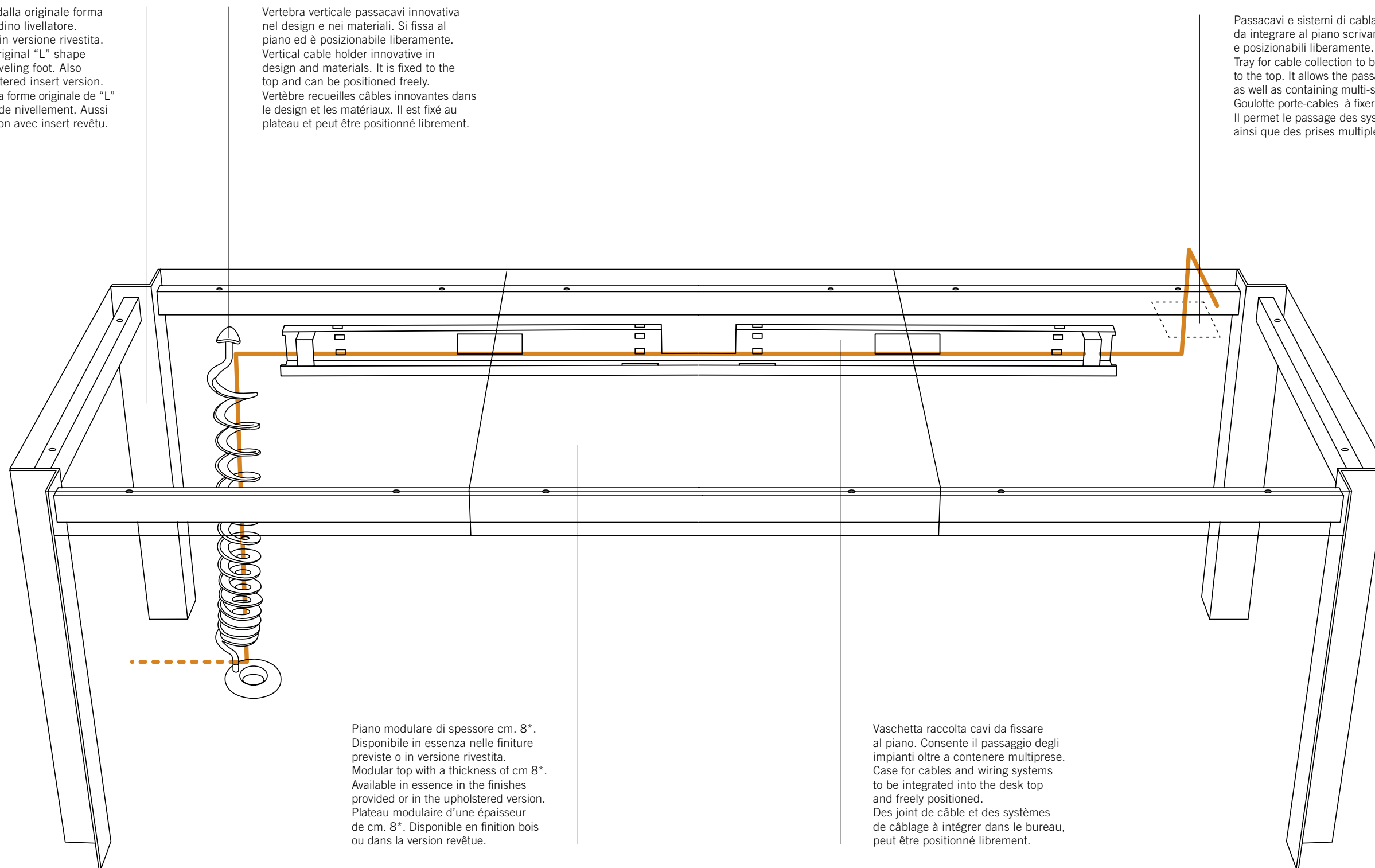

Piano modulare di spessore cm. 8*. Disponibile in essenza nelle finiture previste o in versione rivestita. Modular top with a thickness of cm 8*. Available in essence in the finishes provided or in the upholstered version. Plateau modulaire d'une épaisseur de cm. 8*. Disponible en finition bois ou dans la version revêtue.

Vaschetta raccolta cavi da fissare al piano. Consente il passaggio degli impianti oltre a contenere multiprese. Case for cables and wiring systems to be integrated into the desk top and freely positioned. Des joint de câble et des systèmes de câblage à intégrer dans le bureau, peut être positionné librement.

SCRIVANIE / DESKS / BUREAUX

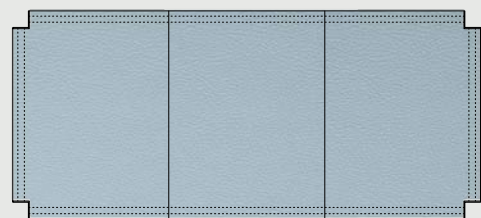

RIUNIONE / MEETING / REUNION

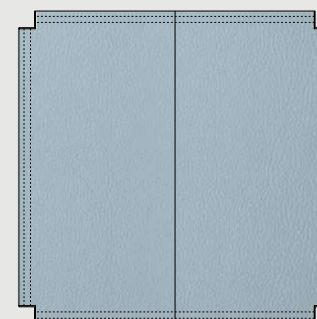
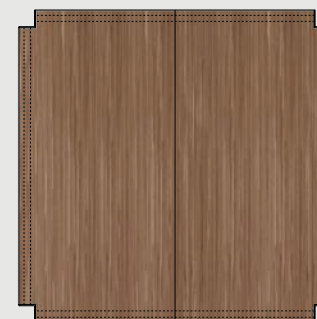

RIUNIONE / MEETING / REUNION



ROGER COLLECTION

Scrivania piano rivestito
Upholstered desk
Bureau avec plateau revetu

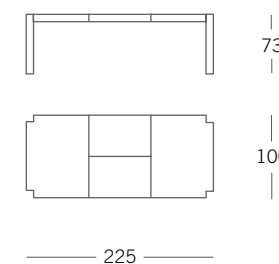

Tavolo meeting piano rivestito
Upholstered meeting table
Tables de réunion avec plateau revetu

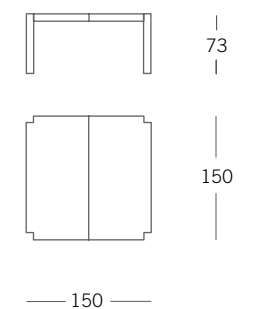

Tavolo meeting piano rivestito
Upholstered meeting table
Tables de réunion avec plateau revetu

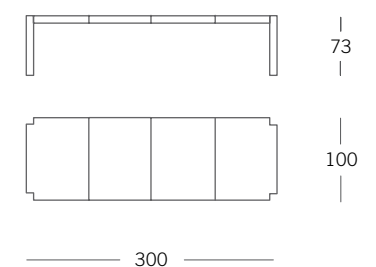

Scrivania piano in legno
Wooden desk
Bureau avec plateau en bois

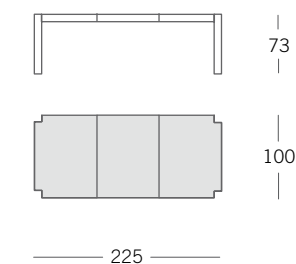

Tavolo meeting piano in legno
Wooden meeting table
Tables de reunion en finition bois

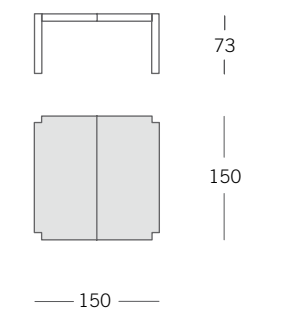

Tavolo meeting piano in legno
Wooden meeting table
Tables de reunion en finition bois

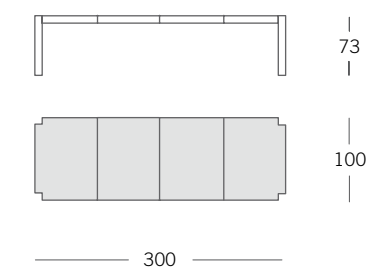

**FIRSTCLASS
DRESSED BY
ARCHITETTO
ROBERTO
BACIOCCHI**

Un aspetto estetico ricercato ed elegante, una struttura solida che trova nella gamba il momento di maggiore enfasi stilistica. Prevista in essenza o rivestita la gamba dalla sezione quadrata e dalla forma originale, rappresenta l'elemento che caratterizza in modo univoco tavoli scrivania e tavoli meeting. I piani sono realizzati con sapiente maestria artigianale e conferiscono alle realizzazioni Firstclass raffinatezza ed esclusività. Firstclass adotta i sistemi di librerie Bookcase e Shelve oltre ai complementi per tavoli.

A refined and elegant aesthetic appearance, a solid structure that finds in the leg the moment of greater stylistic emphasis. Provided veneered or upholstered, the leg, with a square section and an original shape, represents the element that uniquely characterizes desk and meeting tables. The tops are made with skilful craftsmanship and give refinement and exclusivity to Firstclass creations. Firstclass adopts Bookcase and Shelve compositions as well as table complements.



Scrivania 225x100, piano con angoli sagomati e gonna in pelle Avorio 302, gambe in essenza Piacava. Contenitore girevole CAB in essenza Piacava, top e fianchi in pelle Avorio 302. Poltrona Hanami in pelle Ghiaccio 301, retro in velluto Rubelli 008. | Desk 225x100, top with shaped edges and modesty panel in Ivory leather 302, legs in Piacava veneer. Swivel CAB supporting mobile credenza in Piacava veneer, top and sides in Ivory leather 302. Hanami armchair in Ice 301 leather, backside in Rubelli velvet 008. | Bureau 225x100, plateau avec coins façonnés et panneau frontal en cuir Avorio 302, pieds en finition bois Piacava. Meuble pivotante CAB en finition bois Piacava, plateau et côtés en cuir Avorio 302. Fauteuil Hanami en cuir Ghiaccio 301, dos en velours Rubelli 008.

FIRSTCLASS COLLECTION





FIRSTCLASS COLLECTION



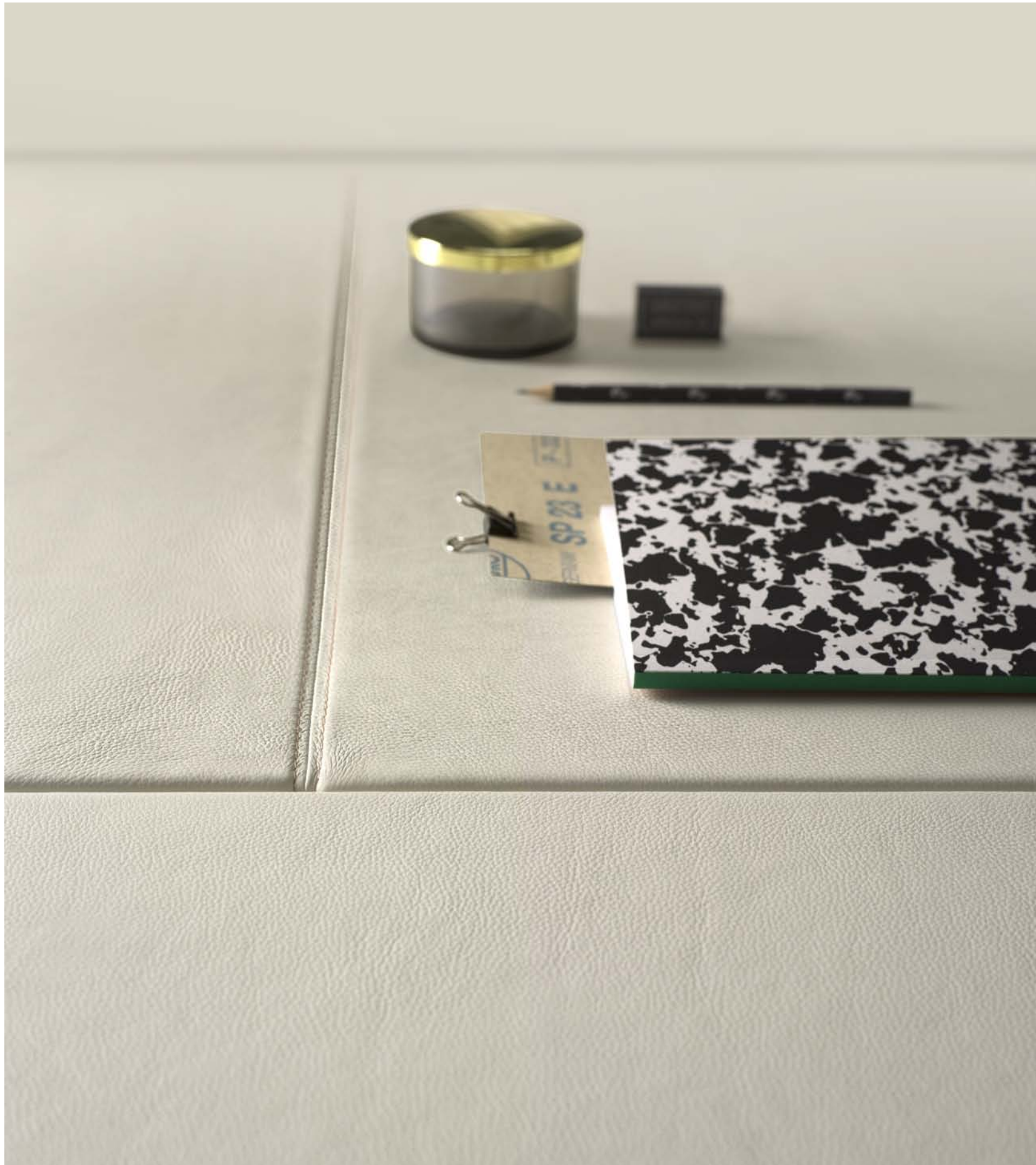

FIRSTCLASS COLLECTION

FIRSTCLASS COLLECTION

Scrivania 225x100 piano con angoli sagomati in essenza Ebano, gambe in pelle Ice 353. Poltrona Deep Executive, interno in velluto Rubelli 015, esterno in velluto Rubelli 014. | Desk 225x100 top with shaped edges in Ebony veneer, legs in Ice leather 353. Deep Executive armchair, frontside in Rubelli velvet 015, backside in Rubelli velvet 014. | Bureau 225x100 plateau avec coins façonnés en finition bois d'ébène, pieds en cuir Ice 353. Fauteuil Executive Deep, intérieur en velours Rubelli 015, extérieur en velours Rubelli 014.



FIRSTCLASS COLLECTION



Divano Vogue Bottom 160x80x73 H in velluto Rubelli 015 e cuscini in pelle Ice 353. Struttura finitura marrone Maserati. Tavolino XAXA 40x65 H base in marmo bianco Carrara, piano HPL nero. Specchiera M1 51x76 finitura oro. | Vogue Bottom sofa 160x80x73 H in Rubelli velvet 015 and cushions in Ice leather 353. Structure in brown "Maserati" finish. Coffee table XAXA 40x65 H with white Carrara marble base and black HPL top. Mirror M1 51x76 with gold finish. | Canapé Vogue Bottom 160x80x73 H en velour Rubelli 015 et coussins en cuir Ice 353. Structure en finition marron Maserati. Table basse XAXA 40x65 H base en marbre blanc de Carrara, plateau en HPL noir. Miroir M1 51x76 en finition dorée.



FIRSTCLASS COLLECTION

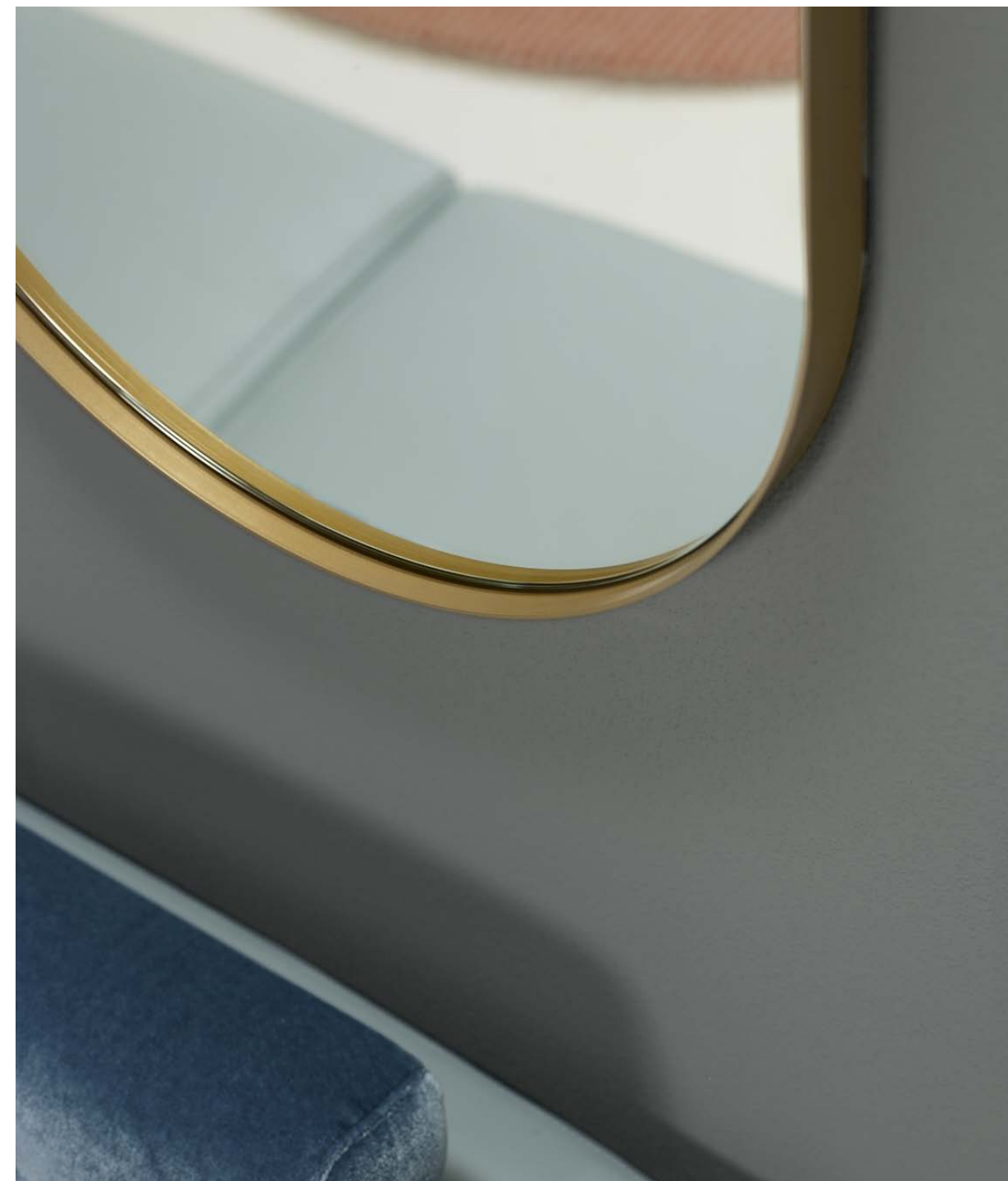

Tavolo riunione 300x120 piano con angoli sagomati in essenza Rovere Gray, gambe in pelle Carioca 333. Poltrona Minimax in velluto Rubelli 005. Mobile Bookcase 93x135H, base metallica Babila e maniglie finitura nero. Top, fianchi e ante in pelle custom Lilla. | Meeting table 300x120, top with shaped edges in Oak Gray veneer, legs in Carioca leather 333. Minimax armchair in Rubelli velvet 005. Bookcase 93x135H, Babila metal base and handles in black finish. Top, sides and doors in custom leather Lilla. | Table de réunion 300x120 avec coins façonnés en finition bois chêne gris, pieds en cuir Carioca 333. Fauteuil Minimax en velours Rubelli 005. Bookcase 93x135H, base en métal Babila et poignées en finition noire. Plateau, côtés et portes en cuir custom Lilla.

FIRSTCLASS COLLECTION



Tavolo riunione 150x150 piano con angoli sagomati in essenza Rovere Gray, gambe in pelle Carioca 333. Poltrona Ginevra in velluto Rubelli 005 | Meeting table 150x150, top with shaped edges in Oak Gray veneer, legs in Carioca leather 333. Ginevra armchair in Rubelli velvet 005. | Table de réunion 150x150 avec coins façonnés en finition bois chêne gris, pieds en cuir Carioca 333. Fauteuil Ginevra en velours Rubelli 005.



FIRSTCLASS COLLECTION



Gamba dall'originale forma a "clessidra" dotata di piedino livellatore. Disponibile in legno o in versione rivestita.
 Leg with an original "Hourglass" shape, equipped with a leveling foot, available in veneered wood or upholsterd.
 Pied avec la forme originale de "Sablier" équipée d'un pied de nivellement, disponible en bois plaqué et revetu.

Vertebra verticale passacavi innovativa nel design e nei materiali. Si fissa al piano ed è posizionabile liberamente.
 Vertical cable holder innovative in design and materials. It is fixed to the top and can be positioned freely.
 Vertèbre recueille câbles innovantes dans le design et les matériaux. Il est fixé au plateau et peut être positionné librement.

Vaschetta raccolta cavi da fissare al piano. Consente il passaggio degli impianti oltre a contenere multiprese.
 Case for cables and wiring systems to be integrated into the desk top and freely positioned.
 Des joint de câble et des systèmes de câblage à intégrer dans le bureau, peut être positionné librement.

Passacavi e sistemi di cablaggio da integrare al piano scrivania. e posizionabili liberamente.
 Tray for cable collection to be fixed to the top. It allows the passage of wiring as well as containing multi-sockets.
 Goulotte porte-cables à fixer au plateau. Il permet le passage des systèmes ainsi que des prises multiples.

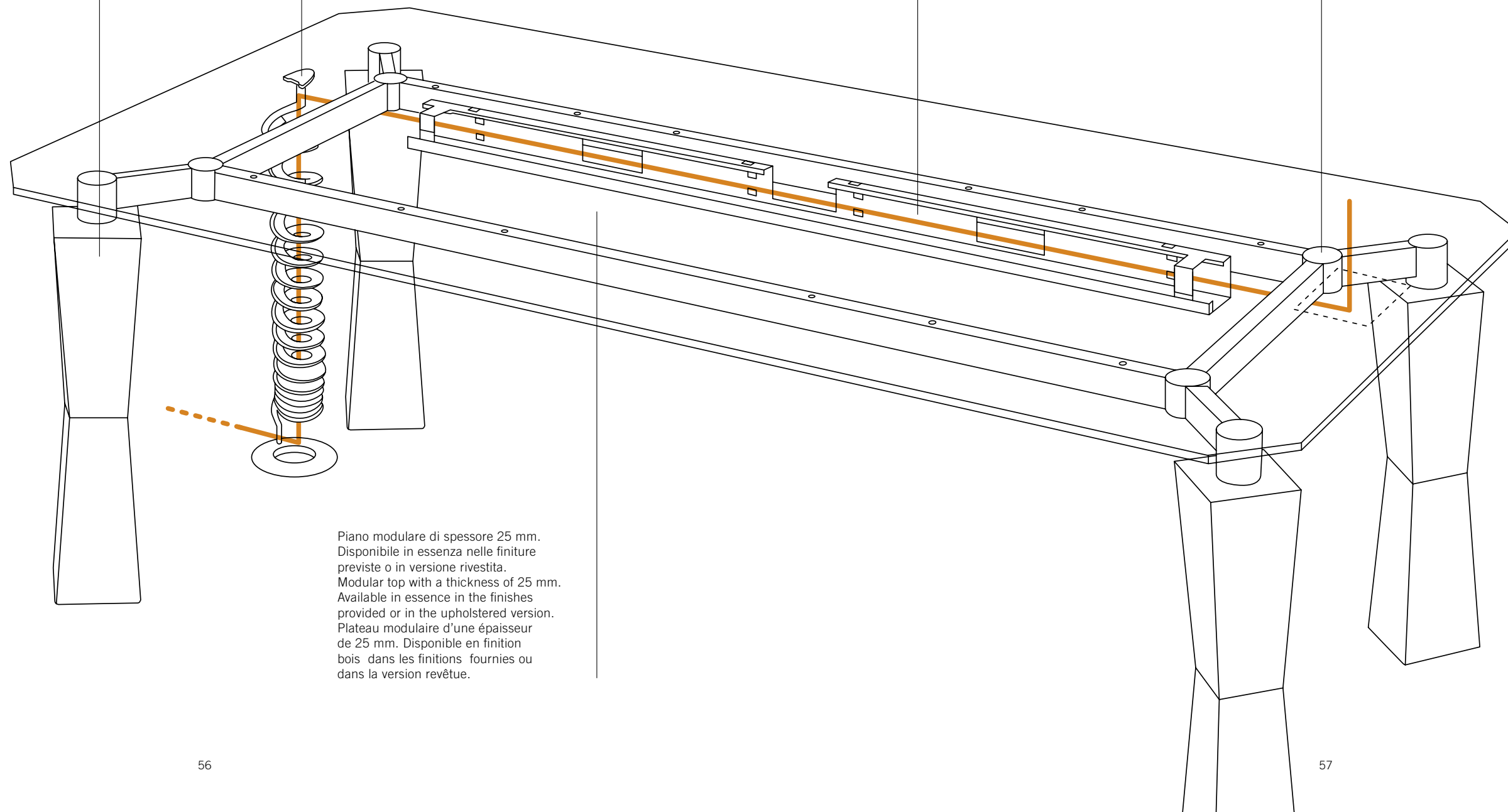

Piano modulare di spessore 25 mm. Disponibile in essenza nelle finiture previste o in versione rivestita.
 Modular top with a thickness of 25 mm. Available in essence in the finishes provided or in the upholstered version.
 Plateau modulaire d'une épaisseur de 25 mm. Disponible en finition bois dans les finitions fournies ou dans la version revêtue.

SCRIVANIE / DESKS / BUREAUX

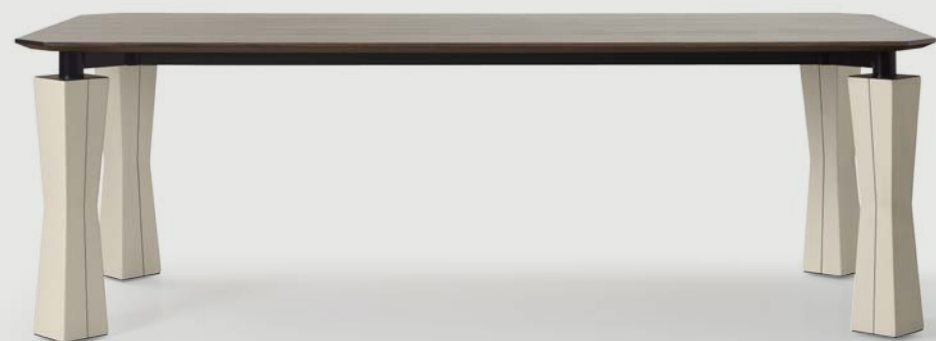
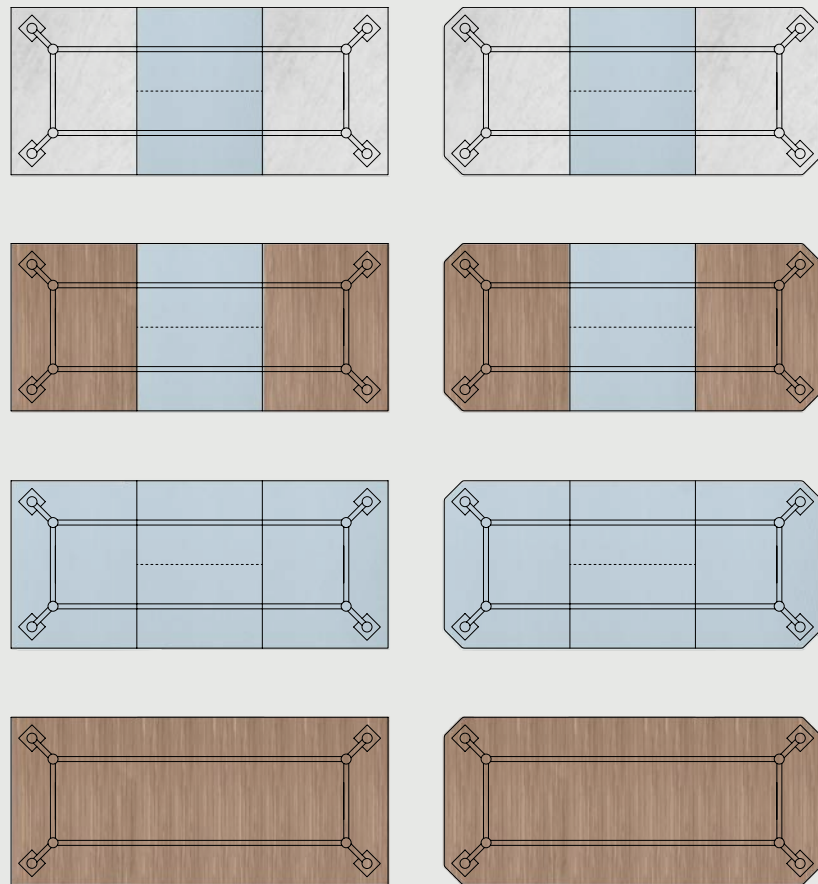

SCRIVANIE CON CAB / DESKS WITH CAB / BUREAUX AVEC CAB

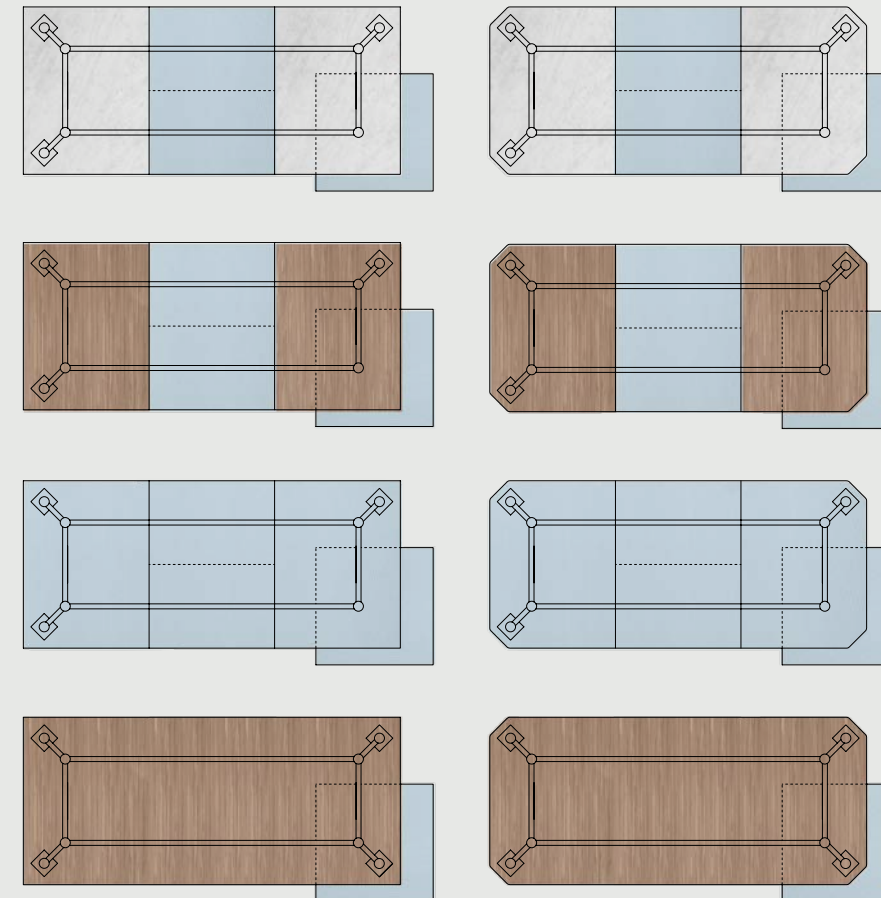

RIUNIONE / MEETING / REUNION CM. 100/120

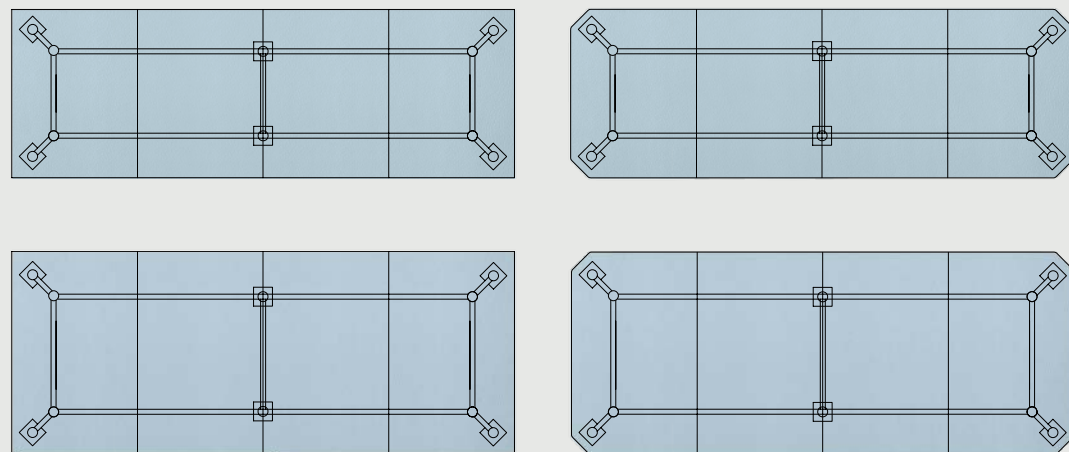

RIUNIONE / MEETING / REUNION CM. 150

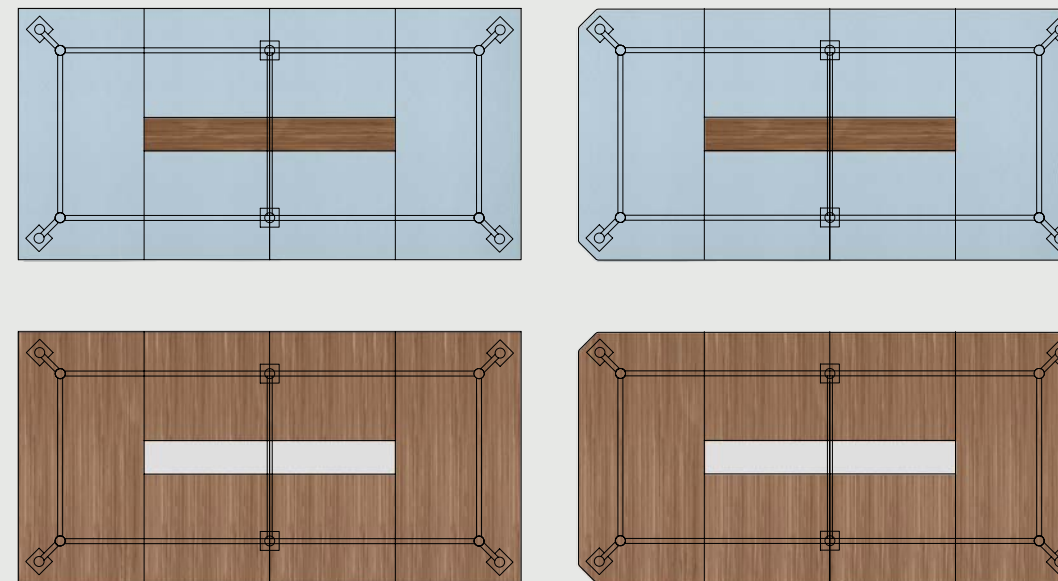

FIRSTCLASS COLLECTION

Scrivania piano rivestito
Upholstered desk
Bureau avec plateau revetu

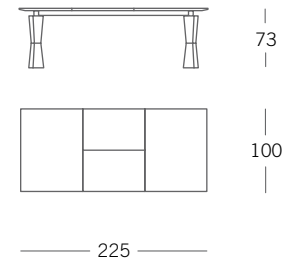

Scrivania piano in legno/marmo e rivestito
Wooden/marble and upholstered desk
Bureau avec plateau en bois/marbre et revetu

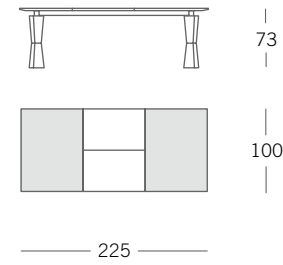

Scrivania piano in legno
Wooden desk
Bureau avec plateau en bois

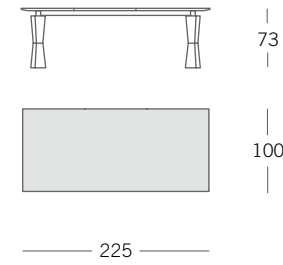

Scrivania piano rivestito con CAB
Upholstered desk with CAB
Bureau avec plateau revetu avec CAB

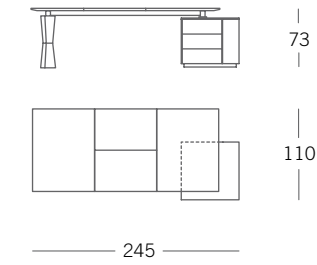

Scrivania piano in legno/marmo e rivestito con CAB
Wooden/marble and upholstered desk with CAB
Bureau avec plateau en bois/marbre et revetu avec CAB

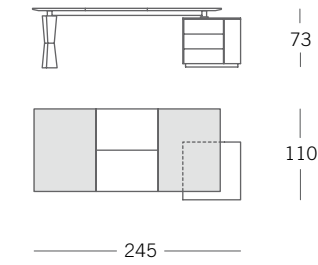

Scrivania piano in legno con CAB
Wooden desk with CAB
Bureau avec plateau en bois avec CAB

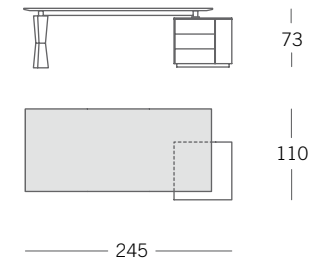

Tavoli meeting piano rivestito o legno
Upholstered or wooden meeting tables
Tables de reunion avec plateau revetu or en bois

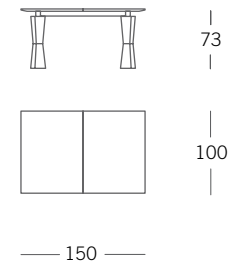

Tavoli meeting piano rivestito o legno
Upholstered or wooden meeting tables
Tables de reunion avec plateau revetu or en bois

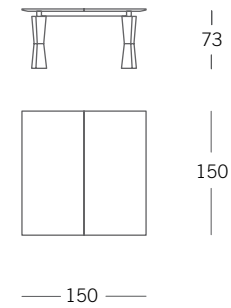

Tavoli meeting piano rivestito o legno
Upholstered or wooden meeting tables
Tables de reunion avec plateau revetu or en bois

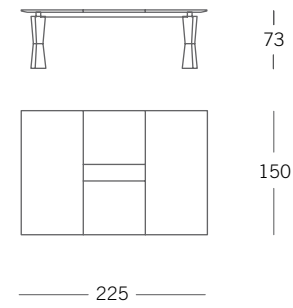

Tavoli meeting piano rivestito o legno
Upholstered or wooden meeting tables
Tables de reunion avec plateau revetu or en bois

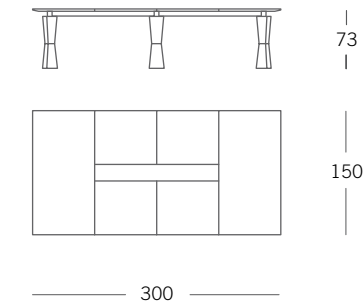

Tavoli meeting piano rivestito o legno
Upholstered or wooden meeting tables
Tables de reunion avec plateau revetu or en bois

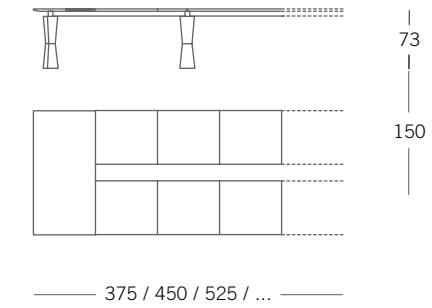

Tavoli meeting piano rivestito
Upholstered meeting tables
Tables de reunion avec plateau revetu

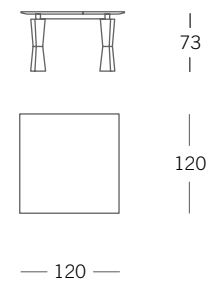

Tavoli meeting piano rivestito
Upholstered meeting tables
Tables de reunion avec plateau revetu

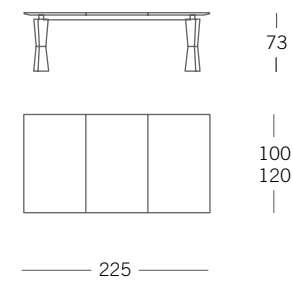

Tavoli meeting piano rivestito
Upholstered meeting tables
Tables de reunion avec plateau revetu

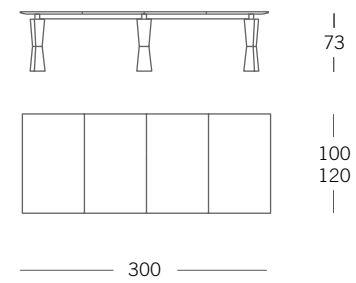

Tavoli meeting piano rivestito
Upholstered meeting tables
Tables de reunion avec plateau revetu

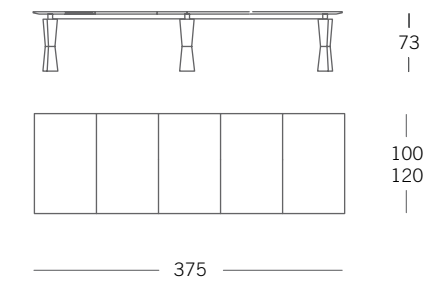

Tavoli meeting piano rivestito
Upholstered meeting tables
Tables de reunion avec plateau revetu

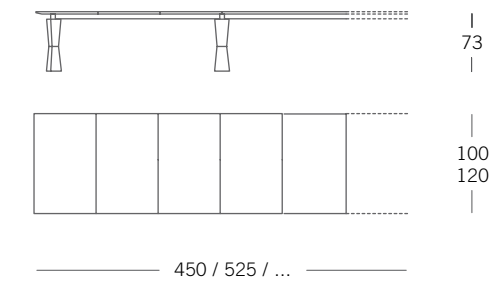

FIRSTCLASS COLLECTION

INFINITY DRESSED BY ARCHITETTO ROBERTO BACIOCCHI

Le proposte Infinity si caratterizzano per il sapiente utilizzo della pelle, cucita con maestria artigianale e accostata in modo originale alle calde finiture in legno. Infinity comprende tavoli meeting dalle forme semplici e dalle dimensioni modulabili all'infinito, tavolo meeting Round dalle forme morbide e stondate e scrivanie dalla linea essenziale e ricercata. La gamba in acciaio conico prevista in molteplici finiture è sempre corredata di piedini cromati. Infinity adotta i sistemi di librerie Bookcase e Shelve.

The main characteristic of the Infinity collection is the skillful usage of the leather, which is with craftsmanship stitched and warmly and originally match to the finishes of the wood. Infinity consists of meeting tables with simple shapes and endless modular dimensions, Round collection with smooth and rounded shapes, essential and researched desks. The steel cone-shaped leg, always equipped with chromed feet, is proposed in different finishes. Infinity chooses Bookcase and Shelves.

Les propositions Infinity se caractérisent par une utilisation habile du cuir, cousu de manière artisanale et assorti originalement aux finitions en bois chaudes. Infinity inclut des tables de réunion avec des formes et des tailles simples pouvant être modulées à l'infini, une table de réunion Round avec des formes arrondies et des bureaux avec une ligne essentielle. Le pied en acier conique est équipée de pieds chromés. Infinity adopte les systèmes de bibliothèque Bookcase et Shelve.



INFINITY COLLECTION

Scrivania 225x100, piano Rovere Gray, elemento centrale in pelle Lime 338, gambe e cassettera su ruote finitura Gesso. Poltrona Amelie in velluto Rubelli 017. Divano Deep 132x80 in pelle ghiaccio 301, tavolo attesa Enoki 50x50 in pelle Lime 338. | 225 x 100 Desk, top in Oak Gray finish, central element in premium Leather Lime 338, chalk finish for the legs and drawer unit. Amelie armchair in Rubelli velvet 017. 132x80 Deep sofa in premium leather Ghiaccio 353. Waiting table Enoki 50x50 in premium leather Lime 338 | Bureau 225x100, plateau en chêne gris, élément central en cuir Lime 338, pieds et tiroir sur roulettes avec finition Platre. Fauteuil Amélie en velours Rubelli 017. Canapé 132x80 en cuir Ghiaccio 353, table d'attente Enoki 50x50 en cuir Lime 338.



INFINITY COLLECTION



INFINITY COLLECTION

Scrivania 225x100, piano in marmo verde Guatemala, elemento centrale in pelle Petrolino 341, gambe finitura Morning. Poltrona Aurora in velluto Rubelli 017, braccioli in pelle Petrolino 341. Mobile Bookcase 93x135H in pelle Petrolino 341, base metallica Babila e maniglie finitura Morning. | 225x100 Desk, top in Guatemala green marble, central element in premium leather Petrolino 341, legs in Morning finish. Aurora armchair in Rubelli velvet 017, armrests in premium leather Petrolino 341. 93x135H Bookcase cabinet in premium leather Petrolino 341, Babila metal frame and handles in Morning finish. | Bureau 225x100, plateau en marbre vert Guatemala, élément central en cuir Petrolino 341, pieds en finition Matin. Fauteuil Aurora en velours Rubelli 017, accoudoirs en cuir Petrolino 341. Bibliothèque 93x135H en cuir Petrolino 341, structure en métal Babila et poignées en finition Matin.



INFINITY COLLECTION

Scrivania 225x100 piano in pelle Avorio 302, gambe finitura Cipria. Scrivania 225x100 con angoli sagomati piano in pelle Petrolio 341, gambe finitura Cromata.
225x100 desk with top in leather Africa 357 and legs in Black finish. 225x100 desk with shaped corners in Petrolio 341 leather, legs in Chromed finish.
Bureau 225x100 plateau en cuir Avorio 302 et peds en finition Noire. Bureau 225x100 avec coins façonnés en cuir Petrolio 341, pieds finition Chromés.



INFINITY COLLECTION



Mobile Bookcase 93x135H, base metallica Babila e maniglie finitura Oro (nella foto sotto in versione Cromo). Top, fianchi e ante in pelle Petrolio 341. | 93x135H Bookcase cabinet, Babila metal frame and handles in Gold finish (version in chromed finish in picture below). Top, sides and doors in premium leather Petrolio 341. | Bibliothèque 93x135H, base en métal Babila et poignées en finition dorée (photo ci-dessous en version Chrome). Plateau, côtés et portes en cuir Petrolio 341.



INFINITY COLLECTION



Tavolo riunione Ø150 con top access integrato, piano in pelle Cenere 354, gambe finitura Oro. Poltrona Deep in pelle Ice 353, retro velluto Rubelli 006 base finitura Marrone Maserati. | 150 Ø cm meeting table with integrated top access, top in premium leather Cenere 354, legs in gold finish. Deep armchair in premium leather Ice 353, back in velvet Rubelli 006, dark brown Maserati finish for the swivel base. | Table de réunion Ø150 avec Top Access intégré, plateau en cuir Cenere 354, pieds finition dorée. Fauteuil Deep en cuir Ice 353, dos de la siège en velour Rubelli 006 base pivotante en finition Marron Maserati.

INFINITY COLLECTION



INFINITY COLLECTION



Tavolo riunione 300x150 con top access integrato in essenza Ebano, piano in pelle Ice 353, gambe finitura marrone Maserati. Poltrona Hyway in velluto Rubelli 007, retro velluto Rubelli 006. Libreria Shelve finitura marrone Maserati. | 300x150 meeting table with integrated top access in Ebony wood, top in premium leather Ice 353, legs in Maserati brown finish. HyWay armchair front in Rubelli velvet 007 and back in Rubelli velvet 006. Dark brown Maserati finish for the metal shelves Shelve. | Table de réunion 300x150 avec Top Access intégré en finition bois ébène, plateau en cuir Ice 353, pieds en finition marron Maserati. Fauteuil Rudy en velours Rubelli 007, dos en velours Rubelli 006. Bibliothèque Shelve en finition marron Maserati.

INFINITY COLLECTION



Gamba conifata in acciaio dotata di piedino livellatore e disponibile in diverse finiture.
Cone-shaped steel leg equipped with adjustable feet and available in different finishes.
Pied conique en acier équipé d'un pied de nivellement et disponible dans différentes finitions.

Vertebra verticale passacavi innovativa nel design e nei materiali. Si fissa al piano ed è posizionabile liberamente.
Vertical cable holder innovative in design and materials. It is fixed to the top and can be positioned freely.
Vertèbre recueille câbles innovantes dans le design et les matériaux. Il est fixé au plateau et peut être positionné librement.

Passacavi e sistemi di cablaggio da integrare al piano scrivania. e posizionabili liberamente.
Tray for cable collection to be fixed to the top. It allows the passage of wiring as well as containing multi-sockets.
Goulotte porte-cables à fixer au plateau. Il permet le passage des systèmes ainsi que des prises multiples.

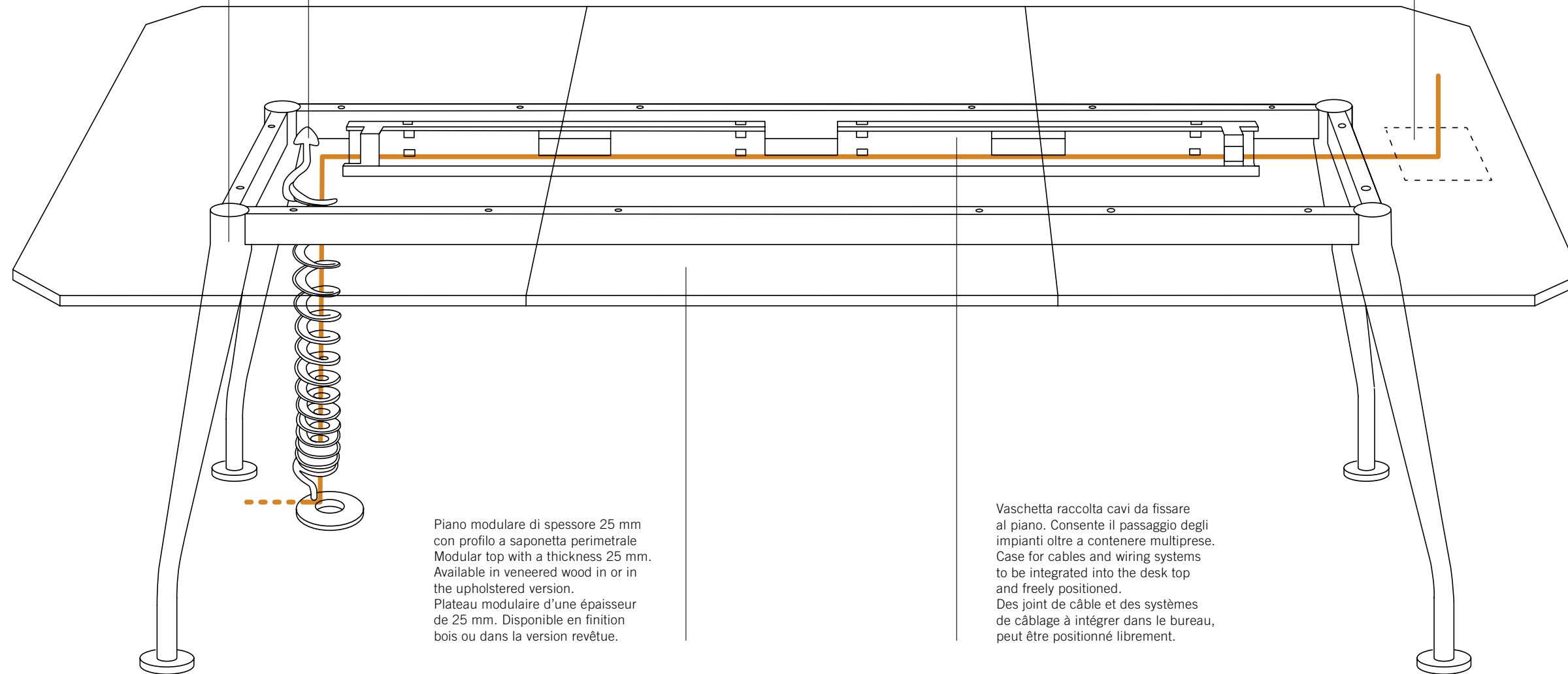

Piano modulare di spessore 25 mm con profilo a saponetta perimetrale.
Modular top with a thickness 25 mm. Available in veneered wood in or in the upholstered version.
Plateau modulaire d'une épaisseur de 25 mm. Disponible en finition bois ou dans la version revêtue.

Vaschetta raccolta cavi da fissare al piano. Consente il passaggio degli impianti oltre a contenere multiprese.
Case for cables and wiring systems to be integrated into the desk top and freely positioned.
Des joint de câble et des systèmes de câblage à intégrer dans le bureau, peut être positionné librement.

SCRIVANIE / DESKS / BUREAUX

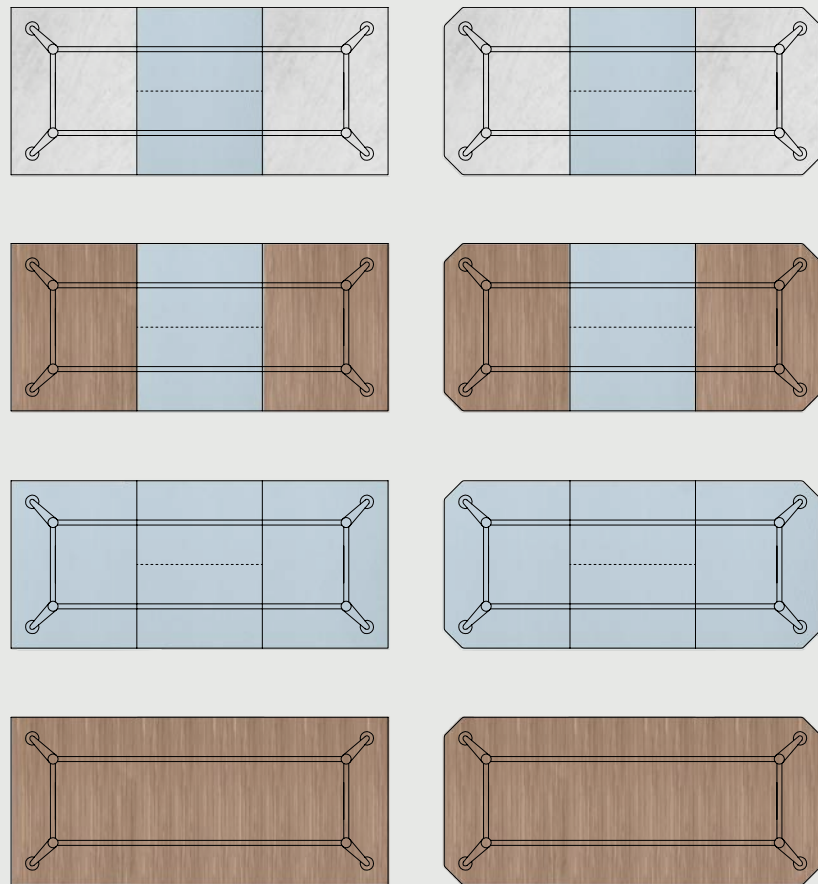

SCRIVANIE CON CAB / DESKS WITH CAB / BUREAUX AVEC CAB

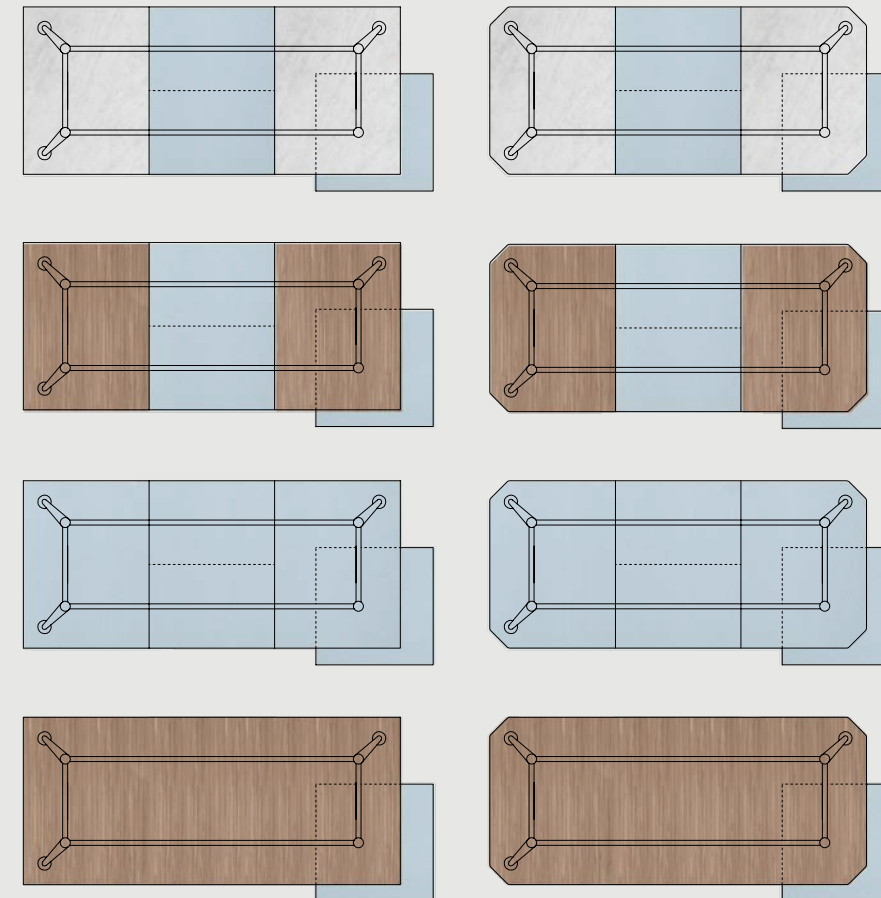

RIUNIONE / MEETING / REUNION CM. 100/120

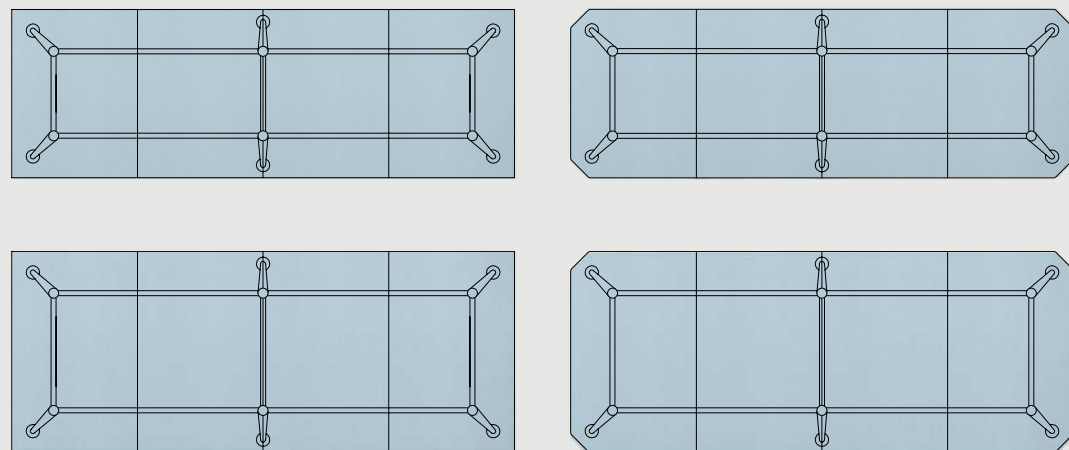

RIUNIONE / MEETING / REUNION CM. 150

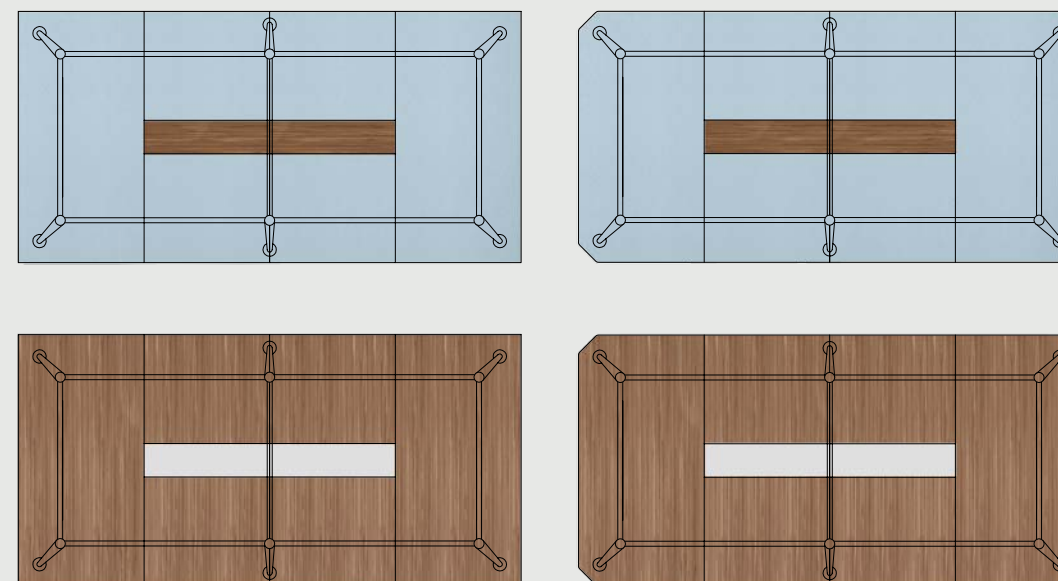

INIFINTY COLLECTION

Scrivania piano rivestito
Upholstered desk
Bureau avec plateau revetu

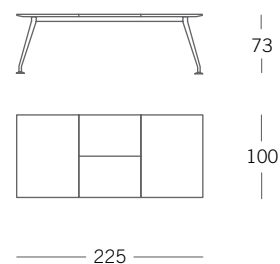

Scrivania piano in legno/marmo e rivestito
Wooden/marble and upholstered desk
Bureau avec plateau en bois/marbre et revetu

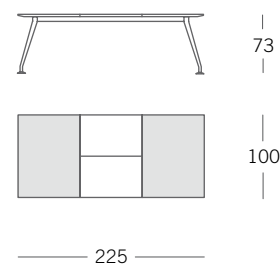

Scrivania piano in legno
Wooden desk
Bureau avec plateau en bois

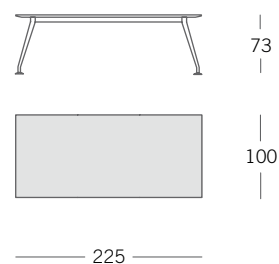

Scrivania piano rivestito con CAB
Upholstered desk with CAB
Bureau avec plateau revetu avec CAB

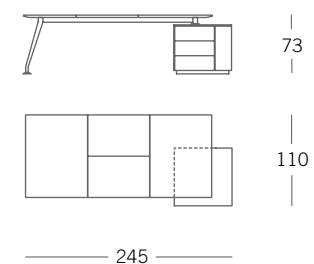

Scrivania piano in legno/marmo e rivestito con CAB
Wooden/marble and upholstered desk with CAB
Bureau avec plateau en bois/marbre et revetu avec CAB

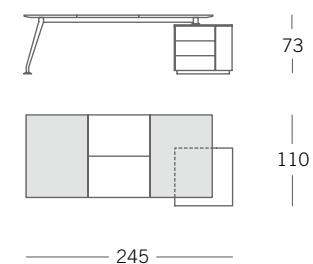

Scrivania piano in legno con CAB
Wooden desk with CAB
Bureau avec plateau en bois avec CAB

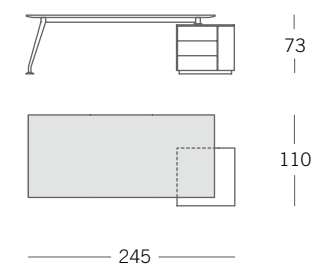

Tavoli meeting piano rivestito o legno
Upholstered or wooden meeting tables
Tables de reunion avec plateau revetu or en bois

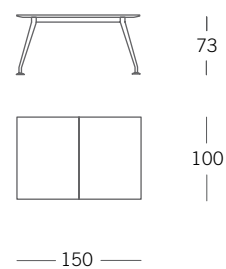

Tavoli meeting piano rivestito o legno
Upholstered or wooden meeting tables
Tables de reunion avec plateau revetu or en bois

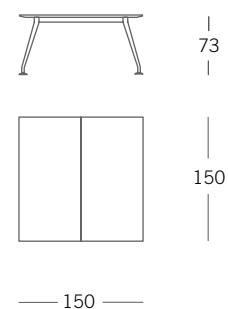

Tavoli meeting piano rivestito o legno
Upholstered or wooden meeting tables
Tables de reunion avec plateau revetu or en bois

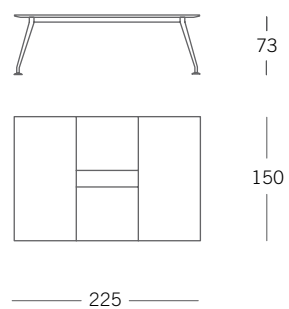

Tavoli meeting piano rivestito o legno
Upholstered or wooden meeting tables
Tables de reunion avec plateau revetu or en bois

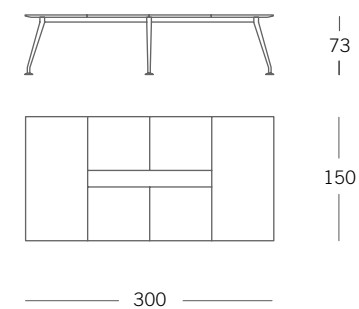

Tavoli meeting piano rivestito o legno
Upholstered or wooden meeting tables
Tables de reunion avec plateau revetu or en bois

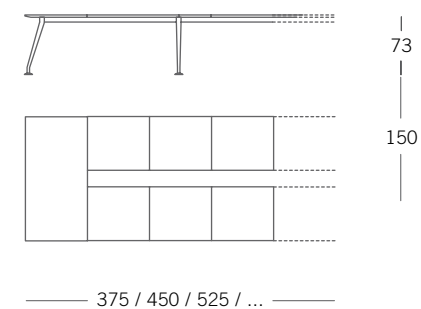

Tavoli meeting piano rivestito
Upholstered meeting tables
Tables de reunion avec plateau revetu

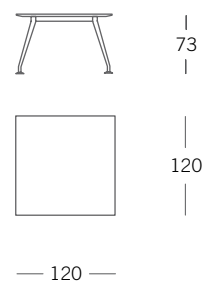

Tavoli meeting piano rivestito
Upholstered meeting tables
Tables de reunion avec plateau revetu

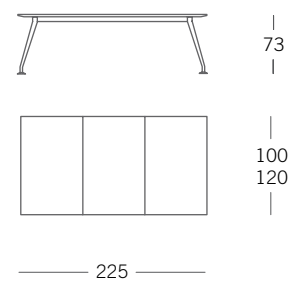

Tavoli meeting piano rivestito
Upholstered meeting tables
Tables de reunion avec plateau revetu

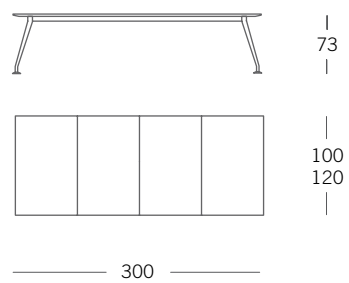

Tavoli meeting piano rivestito
Upholstered meeting tables
Tables de reunion avec plateau revetu

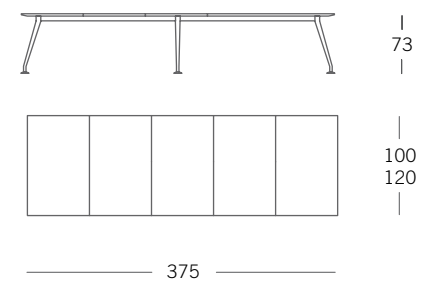

Tavoli meeting piano rivestito
Upholstered meeting tables
Tables de reunion avec plateau revetu

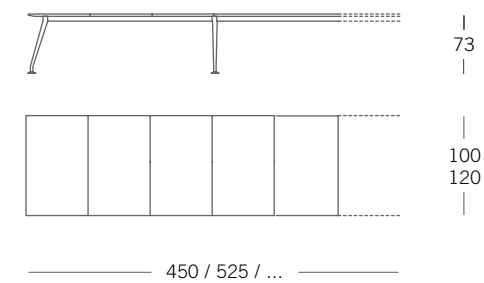

INIFINTY COLLECTION

RIUNIONE ROUND / ROUND MEETING / REUNION ROUND

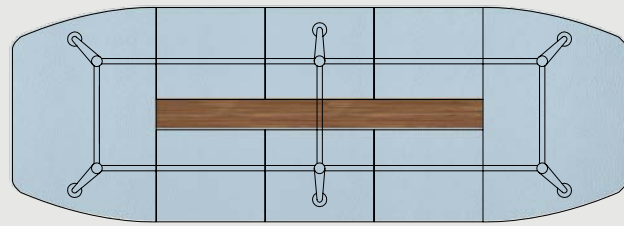
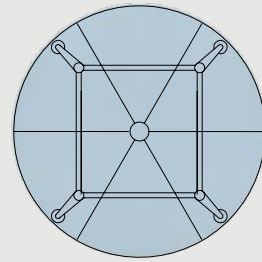

INIFINTY COLLECTION

Tavoli meeting piano rivestito
Upholstered meeting tables
Tables de reunion avec plateau revetu

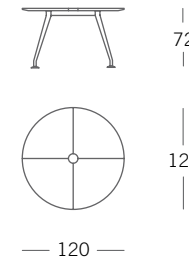

Tavoli meeting piano rivestito
Upholstered meeting tables
Tables de reunion avec plateau revetu

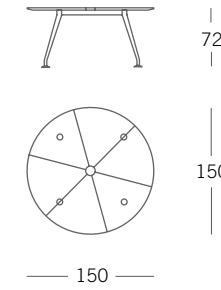

Tavoli meeting piano rivestito
Upholstered meeting tables
Tables de reunion avec plateau revetu

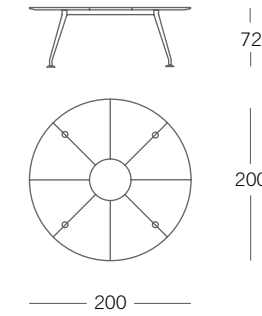

Tavoli meeting piano rivestito
Upholstered meeting tables
Tables de reunion avec plateau revetu

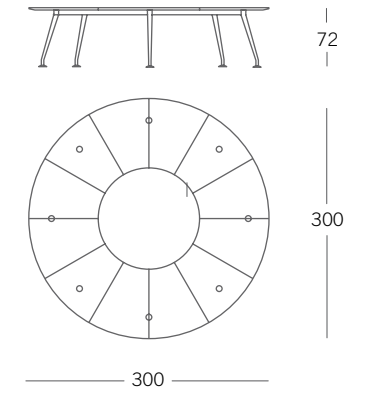

Tavoli meeting piano rivestito
Upholstered meeting tables
Tables de reunion avec plateau revetu

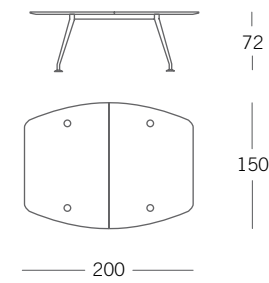

Tavoli meeting piano rivestito
Upholstered meeting tables
Tables de reunion avec plateau revetu

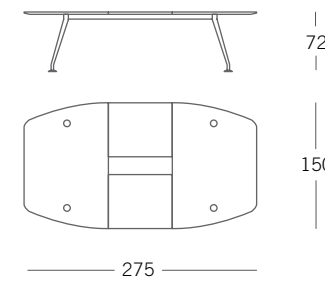

Tavoli meeting piano rivestito
Upholstered meeting tables
Tables de reunion avec plateau revetu

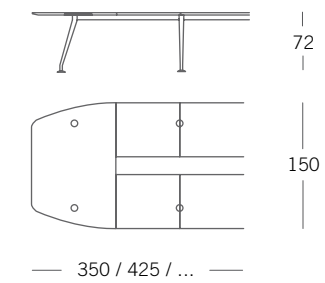

**BARTOLO
DESIGN M. MARTINI
DRESSED BY
ARCHITETTO
R. BACIOCCHI**

Il design minimale e la struttura leggera caratterizzano i tavoli Bartolo. Il tubolare metallico di cm. 4x4 con cui è realizzata la struttura assicura robustezza ed eleganza. Le scrivanie sono previste in più misure nella versione rettangolare mentre i tavoli riunione presentano anche una soluzione quadrata. I tavoli sono studiati per essere collegati in linea, allo stesso modo è possibile integrarli frontalmente per ottenere postazioni multiple. Bartolo adotta le librerie Shelve oltre ai complementi per tavoli.

The minimal design and light structure characterize Bartolo tables. The metal tube of cm. 4x4 with which the structure is made ensures robustness and elegance. The desks are provided in several sizes in the rectangular version while the meeting tables also present a practical square solution. The tables are designed to be connected in line, in the same way it is possible to integrate them frontally to get multiple positions bench. Bartolo adopts Shelve bookcases as well as table complements.



Scrivania 200x100, piano scrivania in HPL nero, struttura finitura marrone Maserati. Poltrona Deep in velluto Rubelli 015 retro in velluto Rubelli 010. Fronte scrivania Minimax in velluto Rubelli 012. Librerie Shelve finitura marrone Maserati. | 200x100 Desk, black HPL top, Maserati dark brown finish structure. | Deep armchair frontside in Rubelli velvet 015 and back in Rubelli velvet 010. Front desk Minimax in Rubelli velvet 012. Shelve bookcases in Maserati dark brown finish. Bureau 200x100, plateau de bureau en HPL Noir, structure de finition marron Maserati. Fauteuil Deep revetu en Rubelli Velvet 015 retro et en velours Rubelli 010. Chaise visiteur Minimax en velours Rubelli 012. Bibliothèques Shelve en finition marron Maserati.

BARTOLO COLLECTION



Libreria Shelve 100x205H finitura marrone Maserati. Divano Loft 150x133H in velluto Rubelli 011, seduta e cuscino in velluto Rubelli 014. | 100x205H Shelve bookcase in dark brown Maserati finish. Loft sofa 150x133H in Rubelli velvet 011, seat and cushion in Rubelli velvet 014. | Bibliothèques Shelve 100x205H en finition marron Maserati. Canapé Loft 150x133H en velours Rubelli 011, assise et coussin en velours Rubelli 014.



BARTOLO COLLECTION



Scrivania 180x75 piano in melaminico Orange, struttura e cassettiere finitura Cipria. Poltrona Rudy large in Camira Era verde 68. Libreria Shelve 100x125H finitura Cipria. | 180x75 Desk, Orange melamine top, structure and drawers in Cipria finish. Armchair Rudy Large in Camira Era green 68. 100x125H Shelve bookshelves in Cipria finish. | Bureau 180x75 cm plateau en mélamine orange, structure et tiroirs en finition Poudre. Fauteuil Rudy large en Camira Era vert 68. Bibliothèque Shelve 100x125H en finition Poudre.

BARTOLO COLLECTION



BARTOLO COLLECTION

Scrivanie in linea 180x75 piano in melaminico Green, struttura e cassettiere finitura gesso. Poltrona Rudy large in lana Gabriel verde E43. Librerie Shelve finitura gesso. | Sequence of desks 180x75, Green melamine tops, structure and drawers in chalk finish. Armchair Rudy Large in Gabriel wool green E43. Shelve bookshelves in chalk finish. | Bureaux alignés 180x75 cm plateau en mélamine Vert, structure et tiroirs avec finition en Plâtre. Fauteuil Rudy large en laine Gabriel vert E43. Bibliothèques Shelve en finition Plâtre.



Scrivania alta 160x100H piano in melaminico Celeste, struttura, cestino finitura marrone Maserati. Sgabello Osvaldo in velluto Rubelli 016. | 160x100H High desk, Celeste melamine top, structure and basket in Maserati dark brown finish. Osvaldo stool in Rubelli velvet 016. | Bureau de 160x100H cm de haut en mélamine Céleste, structure, poubelles en finition marron Maserati. Tabouret Osvaldo en velours Rubelli 016.



BARTOLO COLLECTION



BARTOLO COLLECTION



Tavolo bench 320x152, piano in melaminico Melanzana, struttura e cassettiere finitura Morning. Poltrone Rudy su ruote in Camira Era verde 66. Libreria Shelve 100x125H finitura Morning. | 320x152 Bench table, Aubergine melamine top, structure and drawers in Morning finish. Rudy armchairs on 4 spokes aluminum bases, color Gabriel E43. 100x125H Shelve bookshelves in Morning finish. | Table de banc 320x152, plateau en mélamine Aubergine, structure et tiroir en finition Matin. Fauteuils Rudy sur roulettes, couleur Gabriel E43. Bibliothèque Shelve 100x125H en finition Matin.

BARTOLO COLLECTION



Tavolo riunione 200x100, piano in melaminico Celeste, struttura e librerie finitura marrone Maserati. Poltroncine Deep girevoli su base a 4 razze in Pied Poule, retro pelle 309. Libreria Shelve finitura marrone Maserati. | 200x100 Meeting table Sky blue melamine top, structure and bookcases in Maserati dark brown finish. Deep swivel armchairs on 4 spokes base, frontside in Pied Poule, backside in leather 309. Shelve bookshelves in Maserati dark brown finish. | Table de réunion 200x100, plateau en mélamine Céleste, structure et bibliothèque en finition marron Maserati. Fauteuils pivotants Deep sur base 4 branches en Pied Poule, dos en cuir 309. Bibliothèque Shelve en finition marron Maserati.

BARTOLO COLLECTION



Struttura in tubolare di metallo
cm 4x4 con piedini regolabili
Metal tubular structure
4x4 cm with adjustable feet.
Structure tubulaire en métal
4x4 cm avec pieds réglables.

Vertebra verticale passacavi innovativa
nel design e nei materiali. Si fissa al
piano ed è posizionabile liberamente.
Vertical cable holder innovative in
design and materials. It is fixed to the
top and can be positioned freely.
Vertèbre recueillies câbles innovantes dans
le design et les matériaux. Il est fixé au
plateau et peut être positionné librement.

Vaschetta raccolta cavi da fissare
al piano. Consente il passaggio degli
impianti oltre a contenere multiprese.
Case for cables and wiring systems
to be integrated into the desk top
and freely positioned.
Des joint de câble et des systèmes
de câblage à intégrer dans le bureau,
peut être positionné librement.

Passacavi e sistemi di cablaggio
da integrare al piano scrivania.
e posizionabili liberamente.
Tray for cable collection to be fixed
to the top. It allows the passage of wiring
as well as containing multi-sockets.
Goulotte porte-câbles à fixer au plateau.
Il permet le passage des systèmes
ainsi que des prises multiples.

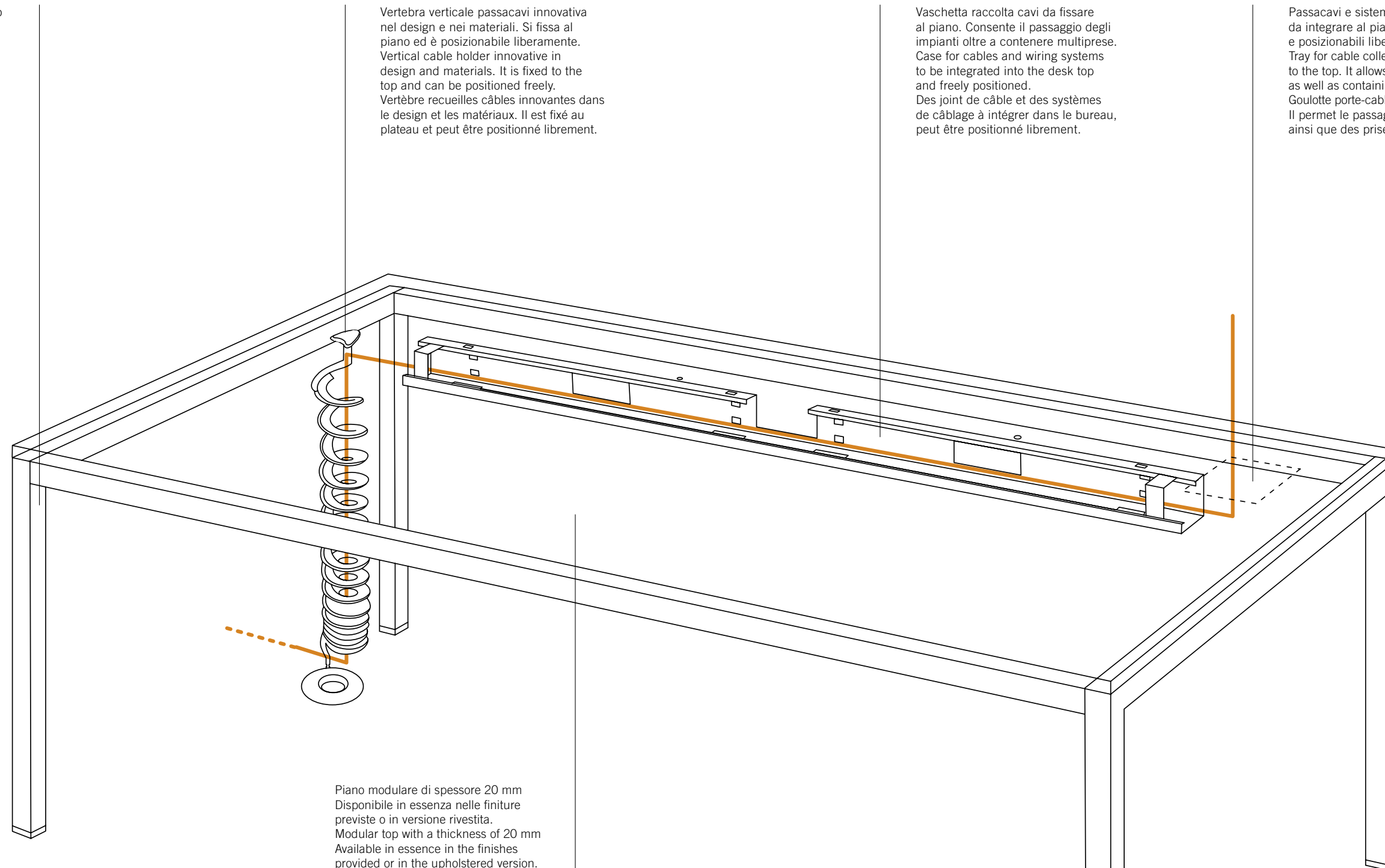

Piano modulare di spessore 20 mm
Disponibile in essenza nelle finiture
previste o in versione rivestita.
Modular top with a thickness of 20 mm
Available in essence in the finishes
provided or in the upholstered version.
Plateau modulaire d'une épaisseur
de 20 mm. Disponible en essence
ou dans la version revêtue.

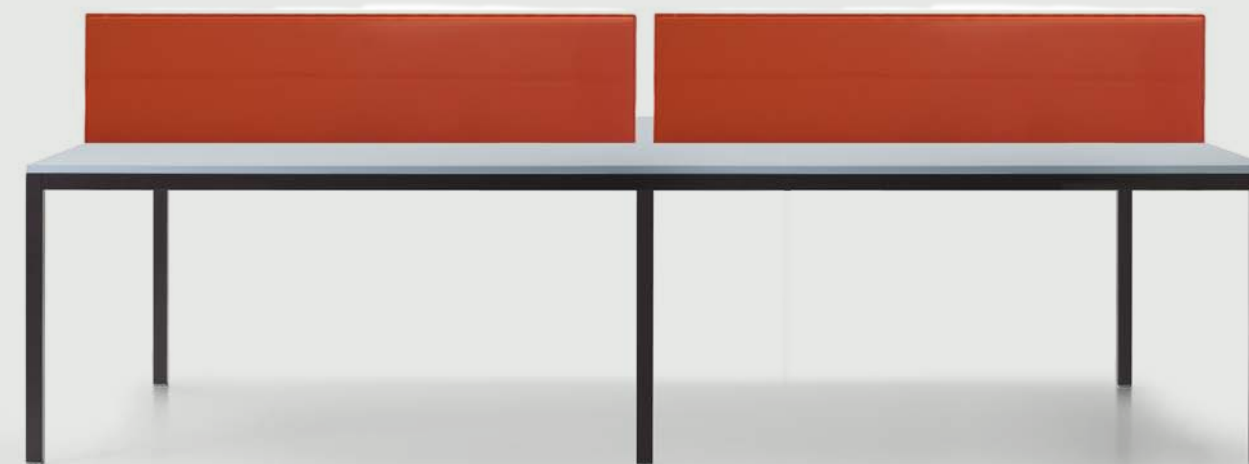
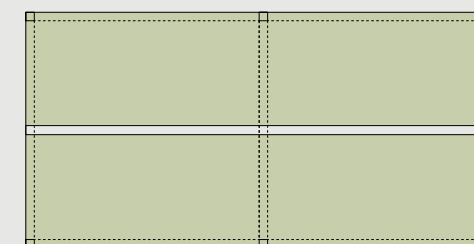
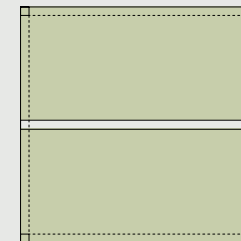
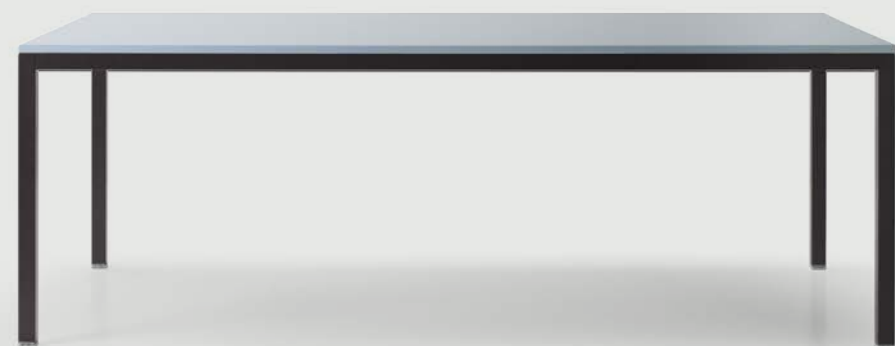
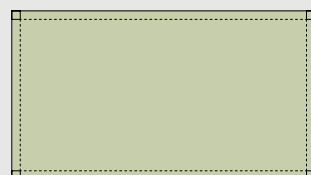

Abbinamenti suggeriti
 Struttura Marrone Maserati
 Piano melaminico Celeste
 Essenza Ebano
 Suggested combinations
 Brown Maserati structure
 Sky blue melamine top
 Ebony essence
 Combinaisons suggérées
 Structure Marron Maserati
 Top mélamine Céleste
 Essence ébène



Tavolo finale/centrale
 Final/central table
 Table finale / centrale

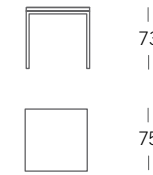

73



75

— 75 —

Tavolo finale/centrale
 Final/central table
 Table finale / centrale



73



75

— 130 —

Tavolo finale/centrale
 Final/central table
 Table finale / centrale



73



75

— 160 / 180 —

Tavolo finale/centrale
 Final/central table
 Table finale / centrale



100



75

— 75 —

Abbinamenti suggeriti
 Struttura Morning
 Piano melaminico Celeste
 Essenza Ebano
 Suggested combinations
 Morning structure
 Aubergine melamine top
 Ebony veneered wood
 Combinaisons suggérées
 Structure Matin
 Top mélamine Aubergine,
 Essence ébène



Tavolo finale/centrale
 Final/central table
 Table finale / centrale



100



75

— 130 —

Tavolo finale/centrale
 Final/central table
 Table finale / centrale

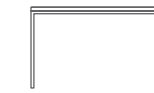

100



75

— 160 / 180 —

Tavolo riunioni
 Meeting tables
 Table de réunion

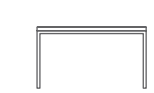

73



130

— 130 —

Tavolo riunioni
 Meeting tables
 Table de réunion



73



100

— 200 —

Abbinamenti suggeriti
 Struttura Cipria
 Piano melaminico Orange
 Essenza Piacava
 Suggested combinations
 Powder pink finish structure
 Orange melamine top
 Piacava veneered wood
 Combinaisons suggérées
 Structure Poudre
 Top mélamine Orange
 Essenza Piacava



Bench finale / centrale
 Final / Central bench
 Final / central bench



73

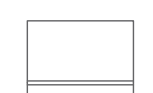

152

— 130 —

Bench finale / centrale
 Final / Central bench
 Final / central bench



73



152

— 160 —

Bench finale / centrale
 Final / Central bench
 Final / central bench

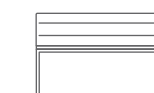

73



152

— 180 —

Abbinamenti suggeriti
 Struttura Gesso
 Piano melaminico Green
 Essenza Rovere Gray
 Suggested combinations
 Chalk finish structure
 Green melamine top
 Gray Oak Essence
 Combinaisons suggérées
 avec structure Platre
 Top en mélamine Verte
 Essence de chêne Gris



**SHELVE
DESIGN
MIRKO
QUINTI**

Shelve è la collezione di librerie metalliche dal design semplice ed essenziale. Le librerie realizzate con tubolare di cm. 3x3 sono disponibili in differenti altezze e larghezze e sono modulabili liberamente per ottenere composizioni di ogni dimensione. Il fianco previsto in versione finale e centrale conferisce robustezza e solidità ad ogni composizione. Le librerie Shelve risolvono le più diverse esigenze di organizzazione del lavoro e dello spazio, in qualsiasi contesto: dagli uffici operativi e direzionali, agli archivi, all'area lounge e contract.

Shelve is the collection of metal bookshelves with a simple and essential design. The bookshelves made of a tube-shaped structure 3x3 cm are available in different heights and widths and can be freely modulated to obtain compositions of any size. The side provided in the final and central version gives strength and solidity to each composition. Shelve bookshelves solve the several needs of work organization and space, in any context: from operational and executive offices, to archives, to the lounge and contract area.

Shelve est la collection de bibliothèques en métal au design simple et essentiel. Les bibliothèques réalisées en tubulaire 3x3 cm sont disponibles en différentes hauteurs et largeurs et peuvent être modulés pour obtenir des compositions de toutes tailles. Le côté conçu dans la version finale et centrale donne de la résistance et de la solidité à chaque composition. Les bibliothèques Shelve rencontrent les besoins les plus différents dans l'organisation du travail et de l'espace, dans tous les contextes: des bureaux opérationnels et executives, aux archives et contract.





SHELVE COLLECTION



SHELVE COLLECTION

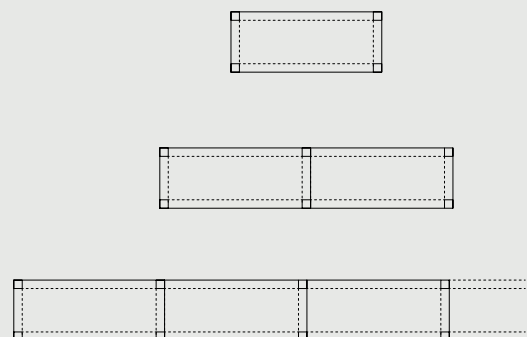

SHELVE COLLECTION

Modulo finale / centrale
End / central element
Elément central / Elément final

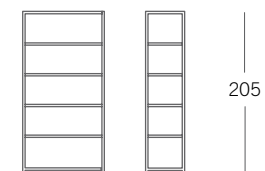

— 100 — — 40 —

Modulo finale / centrale
End / central element
Elément central / Elément final

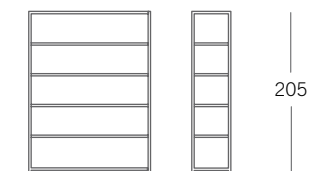

— 160 — — 40 —

Modulo finale / centrale
End / central element
Elément central / Elément final

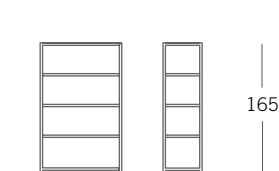

— 100 — — 40 —

Modulo finale / centrale
End / central element
Elément central / Elément final



— 160 — — 40 —

Modulo finale / centrale
End / central element
Elément central / Elément final

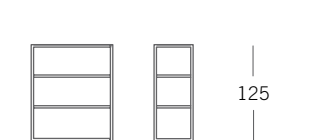

— 100 — — 40 —

Modulo finale / centrale
End / central element
Elément central / Elément final

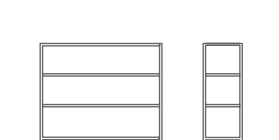

— 160 — — 40 —

Modulo finale / centrale
End / central element
Elément central / Elément final



— 100 — — 40 —

Modulo finale / centrale
End / central element
Elément central / Elément final



— 160 — — 40 —

BOOKCASE QUINTI DESIGN

Il sistema di contenitori Bookcase è pensato per completare tutte le collezioni di arredo Quinti in modo semplice e creativo. Librerie dalla struttura essenziale ma capaci di esprimere con naturalezza un elevato valore materiale, visivo e tattile. Grazie all'ampia gamma di colori e rivestimenti. Ideale supporto per ogni ambiente di lavoro, la collezione Bookcase prevede una sola larghezza di base e due altezze oltre ad un pratico mobile di servizio. Un progetto che unisce libertà compositiva senza limiti, con il pregio della migliore artigianalità italiana.

The Bookcase storages system is conceived to complete all the Quinti's furniture range in a simple and creative way. The minimal structure of the storages are able to convey the high value of the employed materials, in a figurative and tactile way thanks to the wide range of colors and upholsteries. Adaptable in all working space, Bookcase collection is proposed with elements in only one width and two heights as well as a useful independent mobile credenza. A complete program, which combines essentiality and customizable compositions, using the value of the best Italian craftsmanship.

Le système de stockage Bookcase est conçu pour compléter toutes les collections de mobilier Quinti de manière simple et créative. Des bibliothèques avec une structure essentielle mais capables d'exprimer naturellement un haut niveau matérielle, visuelle et tactile, grâce à la large gamme de couleurs et de revêtements. Un support idéal pour chacun environnement de travail, la collection Bookcase fournit une unique largeur de base et deux hauteurs ainsi qu'un meuble de service. Un projet qui combine la liberté de composition et l'essentialité, avec le valeur du meilleur artisanat italien.



BOOKCASE COLLECTION



BOOKCASE COLLECTION

Mobile contenitore a giorno
Bookcase without doors
Bookcase ouvert

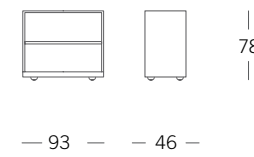

Mobile contenitore a giorno su telaio Babila
Bookcase without doors with Babila frame
Bookcase ouvert sur châssis Babila

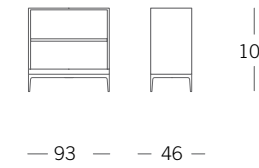

Mobile contenitore a giorno
Bookcase without doors
Bookcase ouvert

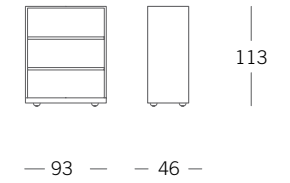

Mobile contenitore a giorno su telaio Babila
Bookcase without doors with Babila frame
Bookcase ouvert sur châssis Babila

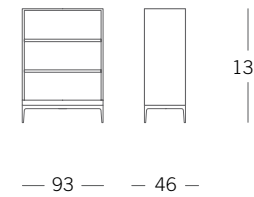

Mobile contenitore con ante
Bookcase with doors
Bookcase avec portes

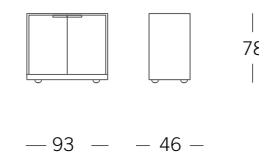

Mobile contenitore con ante su telaio Babila
Bookcase with doors and Babila frame
Bookcase avec portes sur châssis Babila

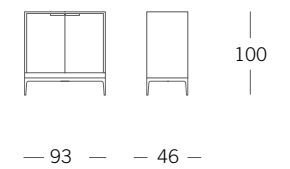

Mobile contenitore con ante
Bookcase with doors
Bookcase avec portes

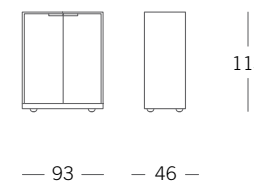

Mobile contenitore con ante su telaio Babila
Bookcase with doors and Babila frame
Bookcase avec portes sur châssis Babila

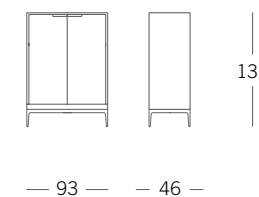

Mobile di servizio su piedini
Mobile credenza with feet
Meuble de service sur pieds

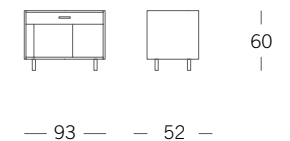

COMPLEMENTI DI ARREDO QUINTI DESIGN

I complementi sono l'essenza della personalità. Oggetti nati in modo indipendente ed allo stesso tempo capaci di integrarsi alla perfezione con i sistemi di arredo. Specchiere, cassettiere, mensole, tavolini attesa, appendiabiti e cestini dal disegno contemporaneo e dalle forme originali. Materiali, finiture e dimensioni studiati per favorire l'inserimento in ogni progetto e per rendere ogni complemento funzionale, unico e personalizzato nel tipico stile Quinti.

I complementi sono l'essenza della personalità. Oggetti nati in modo indipendente ed allo stesso tempo capaci di integrarsi alla perfezione con i sistemi di arredo. Specchiere, cassettiere, mensole, tavolini attesa, appendiabiti e cestini dal disegno contemporaneo e dalle forme originali. Materiali, finiture e dimensioni studiati per favorire l'inserimento in ogni progetto e per rendere ogni complemento funzionale, unico e personalizzato nel tipico stile Quinti.

I complementi sono l'essenza della personalità. Oggetti nati in modo indipendente ed allo stesso tempo capaci di integrarsi alla perfezione con i sistemi di arredo. Specchiere, cassettiere, mensole, tavolini attesa, appendiabiti e cestini dal disegno contemporaneo e dalle forme originali. Materiali, finiture e dimensioni studiati per favorire l'inserimento in ogni progetto e per rendere ogni complemento funzionale, unico e personalizzato nel tipico stile Quinti.

Mensola da parete 100X00 in metallo
finitura bianco viti di fissaggio nere
Metal wall shelf 100X00 in white
finish and black fixing screws.
Étagère murale en métal 100X00 fini-
tion blanche, vignes de fixation noire.



COMPLEMENTI

Cassettiera in metallo 32x53x50H dotata di tre cassetti e ruote. Disponibile nei colori Gesso, Morning, Cipria, Marrone Maserati e Nero. | Metal pedestals 32x53x50H with 3-drawers and castors. Available in Gesso, Morning, Powder Pink, Brown Maserati and Black finish. | Commode en métal 32x53x50H équipé de trois tiroirs et roues. Disponible en couleurs Gesso, Morning, Poudre, Marron Maserati et Noire.





COMPLEMENTI

Specchiere stondate 31x101H / 51x76H, cornice finitura oro, utilizzabili in verticale o orizzontale. | Rounded mirrors 31x101H / 51x76H, frame with gold finish that can be used vertically or horizontally. | Miroirs arrondis 31x101H / 51x76H, cadre en finition dorée, pouvant être utilisé verticalement ou horizontalement.



COMPLEMENTI

Tavoli XAXA Ø40x65/50H base in marmo o cemento e piani in HPL o melaminico. | XAXA Tables Ø40x65/50H, base in Carrara marble or cement and tops in HPL or melamine. | Tables XAXA Ø40x65/50H base en marbre ou ciment et plateau en HPL ou melamine.



Tavolo Enoki Ø50x50H piano in marmo bianco Carrara e base rivestita
Enoki table Ø50x50H, white Carrara marble top and upholstered base.
Table Enoki Ø50x50H Plateau en marbre blanc de Carrara et base revetu.

Cestino in metallo stondato
25x25x35H finitura nero.
Rounded metal basket
25x25x35H, black finish.
Poubelle en métal arrondi
25x25x35H, finition noire.



COMPLEMENTI

Appendiabiti Freestanding in metallo Ø35x170H finitura bianco e nero e pomoli
finitura oro. | Metal Freestanding coathanger Ø35x170H, black and white finish
and hooks in gold finish. | Portemanteau Freestanding en métal Ø35x170H,
finition noir et blanc et bras en finition dorés.

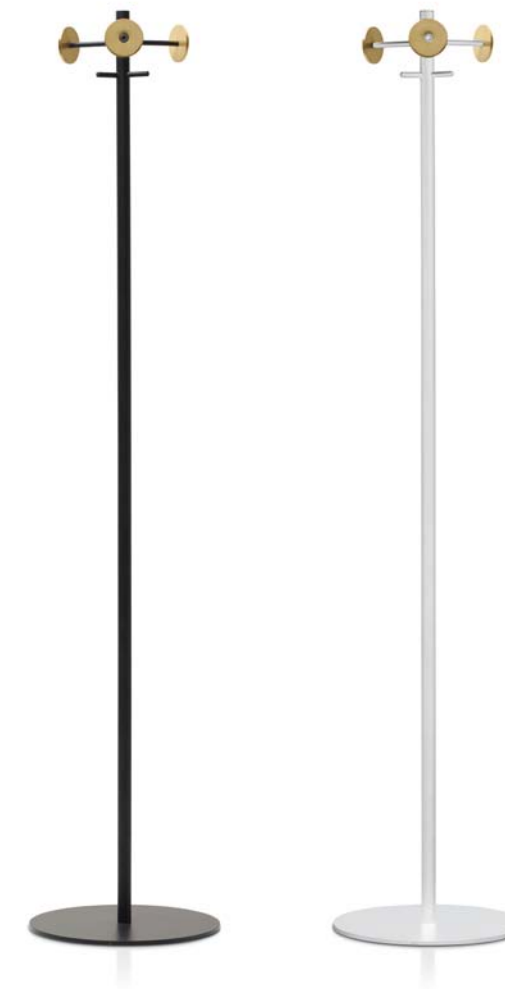



TURN, 39x11,2 cm



LINK, 15,5x13 cm



SLIDE, 12x12 cm



PAD 9x12,5/19 cm



IMX15, 18x5 cm



ROUND, Ø4 cm



SQUARE, 4x4 cm



CHARGER, Ø9 cm



HELIX, 70/110 cm

PELLE PREMIUM

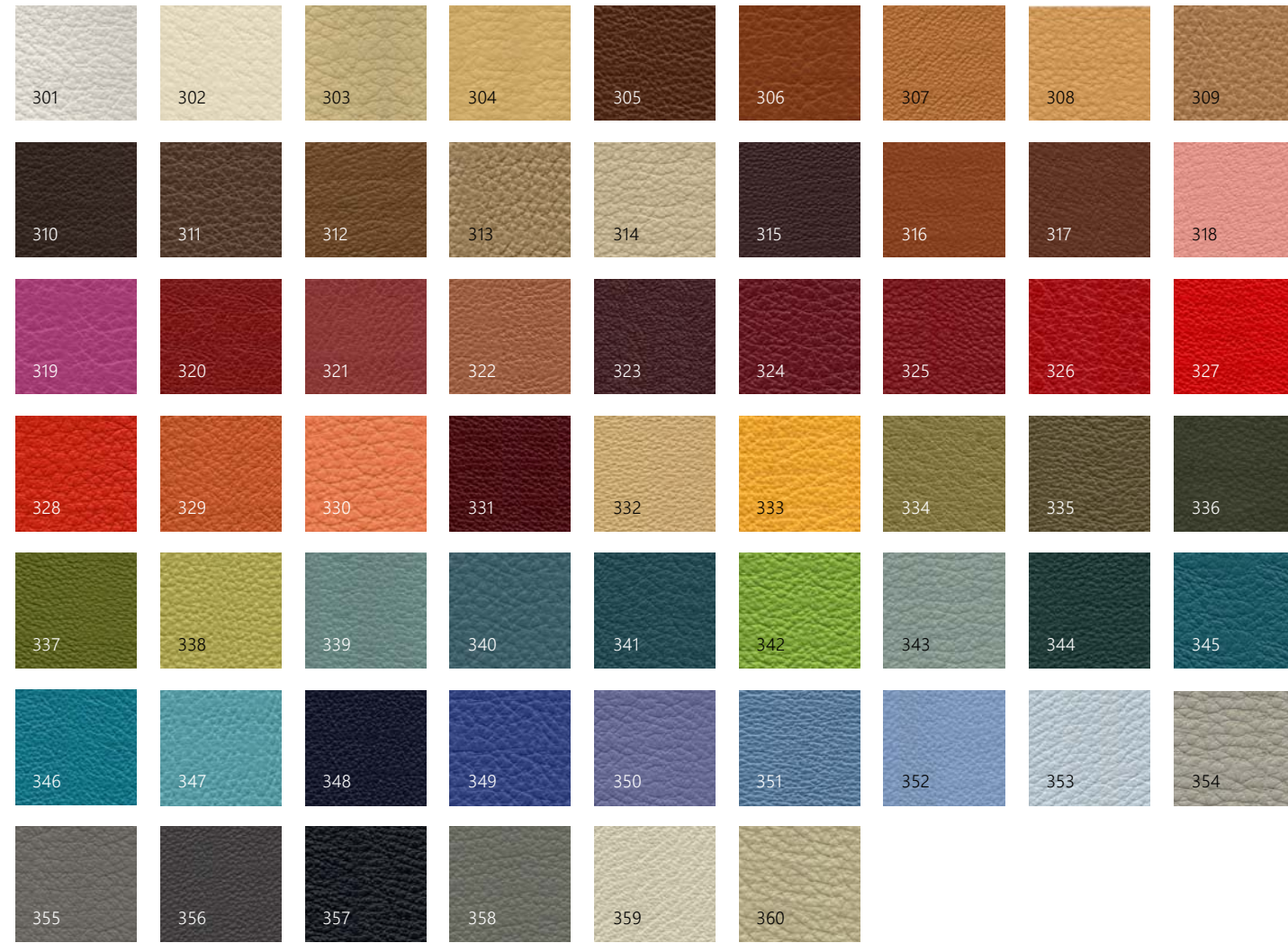

PELLE LEATHER



ECOPELLE

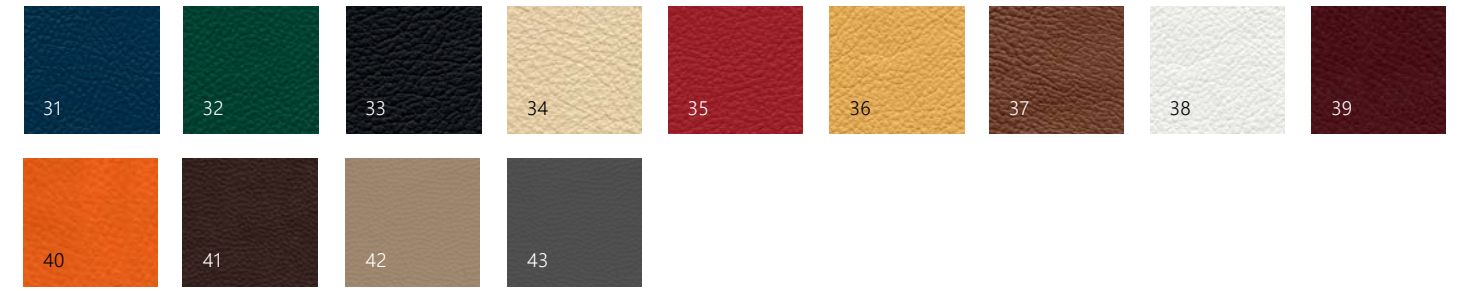

SISTEMA PRO



MARMO / MARBLE / MARBRE



ESSENZA / VENEER / ESSENCE

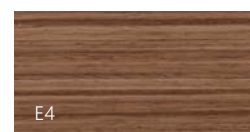

MELAMINICO / MELAMINE/ MELAMINE

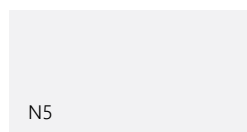

METALLO / METAL / METAL

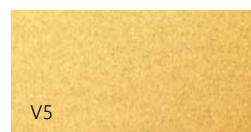
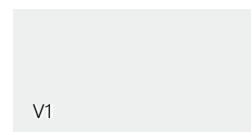

vivax IRODABÚTOR

4026 Debrecen, Hunyadi utca 8.
Tel. +36 52 524 540
Fax. +36 52 524 541
Mobil. +36 30 336 0699
Email. vivax@vivax.hu, tervezes@vivax.hu
www.vivax.hu

2045 Törökbálint, Tópark utca 1/a.
(MaxCity Lakberendezési Áruház, II. em. 232. ID Design)
Tel. +36 23 444 707
Fax. +36 23 444 708
Mobil. +36 30 968 5232
Email. budapest@vivax.hu

3525 Miskolc, Széchenyi utca 7.
(Pátria Üzletház 1.emelet)
Tel. +36 46 413 920
Fax. +36 46 413 921
Mobil. +36 30 903 9255
Email. vivaxmiskolc@vivax.hu



www.facebook.com/vivaxiroda