

SUNDAY

**NARDI**  
YOUR OUTDOOR LIVING

  
**vivax**



## SUNDAY

Da 25 anni Nardi lavora per far sentire bene le persone proponendo arredi per l'outdoor dal carattere giovane, frizzante, coloratissimo ... uno stile easy-chic che interpreta la voglia di vivere all'aria aperta.

Tavoli, sedute, poltroncine relax, lettini prendisole dai colori pieni, brillanti e resistenti agli agenti atmosferici, atossici, completamente riciclabili e, in alcuni casi, anche allungabili o ripiegabili.

Tutto rigorosamente Made in Italy.

Per respirare gioia e relax, per sentirsi bene e far star bene gli altri.  
Nardi, #feelingbetter

For 25 years Nardi has strived to make people feel better by creating fresh, colourful and jazzy outdoor furniture... Nardi brings an easy-chic style which interprets its clients desire to enjoy life in the open air.

Tables, chairs, relaxing armchairs and sunbeds with colourful designs, bright features, created for all types of weather, non-toxic, entirely recyclable and, in some cases, even foldable or extendable.

All Nardi's furniture is rigorously Made in Italy.

Breathe in happiness and relaxation.

Feel better and make others feel better too.

Nardi, #feelingbetter





## LEVANTE \_ BORA





LEVANTE\_ BORA







LEVANTE \_ BORA

NARDI

6



LEVANTE

NARDI

7





## LIBECCIO \_ ACQUAMARINA





NARDI

10

NARDI

11





ACQUAMARINA







## MAESTRALE \_ MUSA





MAESTRALE 220 \_ MUSA





MAESTRALE 220\_ MUSA



MUSA





## STEP \_ ACQUAMARINA \_ DARSENA





ACQUAMARINA\_STEP



DARSENA\_STEP





## SPRITZ \_ ZAC









ZAC CLASSIC



SPRITZ \_ ZAC SPRING





## ALFA \_ OMEGA









OMEGA

NARDI

34



OMEGA

NARDI

35



**schede tecniche**  
**technical details**



## BORA

polipropilene fiberglass

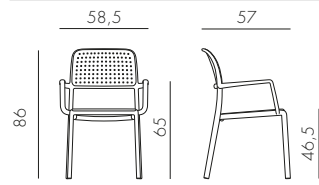

4,4 kg  
n. pz. 6



BIANCO 40242.00.000.06	ANTRACITE 40242.02.000.06	CAFFÈ 40242.05.000.06	ROSSO 40242.07.000.06	TORTORA 40242.10.000.06	AGAVE 40242.16.000.06	CELESTE 40242.39.000.06
---------------------------	------------------------------	--------------------------	--------------------------	----------------------------	--------------------------	----------------------------

## RIVA BISTROT

polipropilene fiberglass

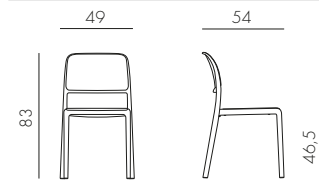

4 kg  
n. pz. 6



BIANCO 40247.00.000.06	ANTRACITE 40247.02.000.06	CAFFÈ 40247.05.000.06	ROSSO 40247.07.000.06	TORTORA 40247.10.000.06	AGAVE 40247.16.000.06	CELESTE 40247.39.000.06
---------------------------	------------------------------	--------------------------	--------------------------	----------------------------	--------------------------	----------------------------

## BORA BISTROT

polipropilene fiberglass

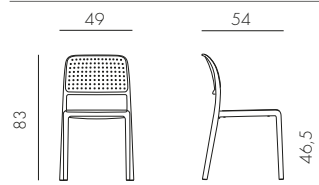

3,7 kg  
n. pz. 6



BIANCO 40243.00.000.06	ANTRACITE 40243.02.000.06	CAFFÈ 40243.05.000.06	ROSSO 40243.07.000.06	TORTORA 40243.10.000.06	AGAVE 40243.16.000.06	CELESTE 40243.39.000.06
---------------------------	------------------------------	--------------------------	--------------------------	----------------------------	--------------------------	----------------------------

## COSTA

polipropilene fiberglass

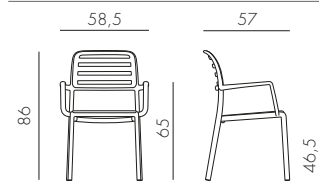

4,5 kg  
n. pz. 6



BIANCO 40244.00.000.06	ANTRACITE 40244.02.000.06	CAFFÈ 40244.05.000.06	ROSSO 40244.07.000.06	TORTORA 40244.10.000.06	AGAVE 40244.16.000.06	CELESTE 40244.39.000.06
---------------------------	------------------------------	--------------------------	--------------------------	----------------------------	--------------------------	----------------------------

## RIVA

polipropilene fiberglass

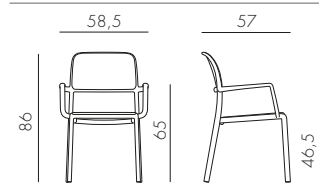

4,6 kg  
n. pz. 6



BIANCO 40246.00.000.06	ANTRACITE 40246.02.000.06	CAFFÈ 40246.05.000.06	ROSSO 40246.07.000.06	TORTORA 40246.10.000.06	AGAVE 40246.16.000.06	CELESTE 40246.39.000.06
---------------------------	------------------------------	--------------------------	--------------------------	----------------------------	--------------------------	----------------------------

## COSTA BISTROT

polipropilene fiberglass

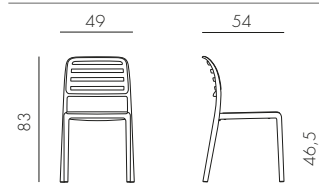

3,9 kg  
n. pz. 6



BIANCO 40245.00.000.06	ANTRACITE 40245.02.000.06	CAFFÈ 40245.05.000.06	ROSSO 40245.07.000.06	TORTORA 40245.10.000.06	AGAVE 40245.16.000.06	CELESTE 40245.39.000.06
---------------------------	------------------------------	--------------------------	--------------------------	----------------------------	--------------------------	----------------------------



## ACQUAMARINA

polipropilene fiberglass



## DARSENA

polipropilene fiberglass



## CUSCINO ACQUAMARINA

tessuto



## CUSCINO DARSENA

tessuto



## ZAC CLASSIC

polipropilene fiberglass



## ZAC SPRING

polipropilene fiberglass



## MUSA

polipropilene alluminio



# Variazioni di colore sono da ritenersi standard e naturali nei tessuti acrilici tinto filo. Posizionare in zone d'ombra - Colour variations are to be considered standard and natural in yarn-dyed acrylic fabrics. Position in shaded areas - Les variations de couleur des tissus acryliques au fil teint sont standard et naturelles. Placer dans des zones ombragées - Farbveränderungen sind als Standard und in im Garn gefärbten Acrylgeweben als natürlich zu betrachten. In schattigen Bereichen aufstellen - Las variaciones de color son normales y naturales en las telas acrílicas teñidas en hilo. Colocar en zonas de sombra - As variações de cor são consideradas standard e naturais nos tecidos acrílico tingidos com fio. Posicionar em zonas de sombra - Boyalı akrilik iplik kumaşlarda renk değişiklikleri standart ve doğal kabul edilir. Gölge alanlara yerleştiriniz - Изменения цвета следует считать нормой, они являются естественными в случае акриловых тканей с окрашенными волокнами. Размещать в тени.



## ALFA

polipropilene  
tessuto sintetico

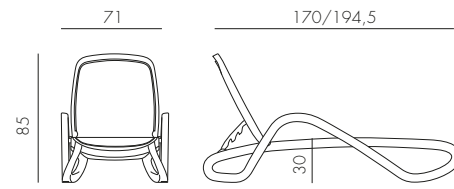

14 kg  
n. pz. 17



Tessuto ricambiabile  
Replaceable fabric  
Tissu changeable  
Auswechselbarer Stoff  
Tela substituível  
Técidos recambiáveis  
Değiştirilebilen Kumaş  
Съемная ткань

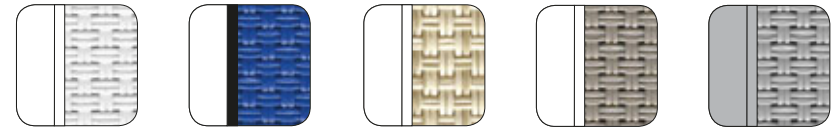

BIANCO  
bianco  
40416.00.108

BIANCO  
blu  
40416.00.112

BIANCO  
beige  
40416.00.115

BIANCO  
tortora  
40416.00.124

GRIGIO  
grigio  
40416.03.086



ANTRACITE  
trama antracite  
40416.02.116

CAFFÈ  
beige  
40416.05.115

CAFFÈ  
trama caffè  
40416.05.117

TORTORA  
tortora  
40416.10.124

## OMEGA

polipropilene  
tessuto sintetico

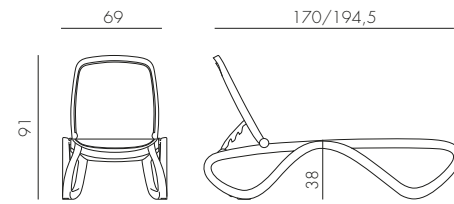

14,3 kg  
n. pz. 18



Tessuto ricambiabile  
Replaceable fabric  
Tissu changeable  
Auswechselbarer Stoff  
Tela substituível  
Técidos recambiáveis  
Değiştirilebilen Kumaş  
Съемная ткань

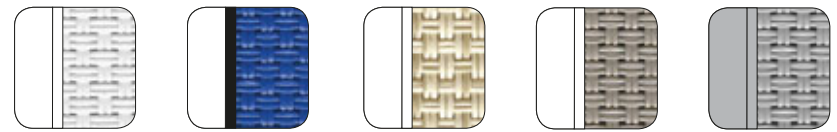

BIANCO  
bianco  
40417.00.108

BIANCO  
blu  
40417.00.112

BIANCO  
beige  
40417.00.115

BIANCO  
tortora  
40417.00.124

GRIGIO  
grigio  
40417.03.086



ANTRACITE  
trama antracite  
40417.02.116

CAFFÈ  
beige  
40417.05.115

CAFFÈ  
trama caffè  
40417.05.117

TORTORA  
tortora  
40417.10.124

NARDI

## PARASOLE

ALFA - OMEGA

polipropilene  
tessuto sintetico

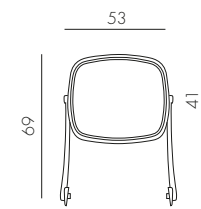

1,4 kg  
n. pz. 1

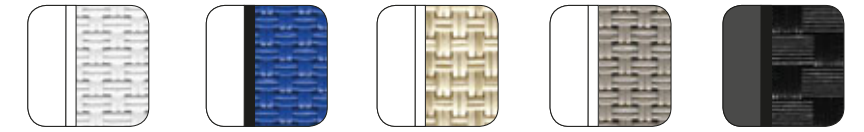

BIANCO  
bianco  
40418.00.108

BIANCO  
blu  
40418.00.112

BIANCO  
beige  
40418.00.115

BIANCO  
tortora  
40418.00.124

ANTRACITE  
trama antracite  
40418.02.116



CAFFÈ  
beige  
40418.05.115

CAFFÈ  
trama caffè  
40418.05.117

TORTORA  
tortora  
40418.10.124

## RICAMBIO

ALFA - OMEGA

resina acetica  
tessuto sintetico

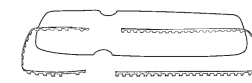

1,6 kg  
n. pz. 1

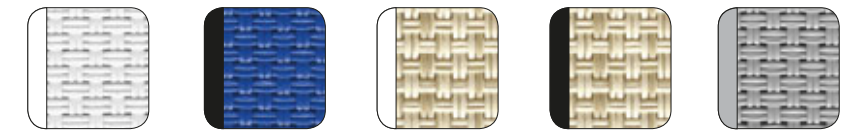

bianco  
40424.00.108

blu  
40424.00.112

beige  
40424.01.115

beige  
40424.00.115

grigio  
40424.03.086

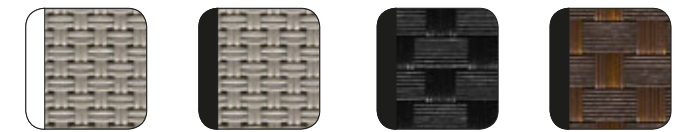

tortora  
40424.00.124

tortora  
40424.01.124

trama antracite  
40424.00.116

trama caffè  
40424.00.117

NARDI



## LIBECCIO 6/8

durelTOP - polipropilene  
alluminio

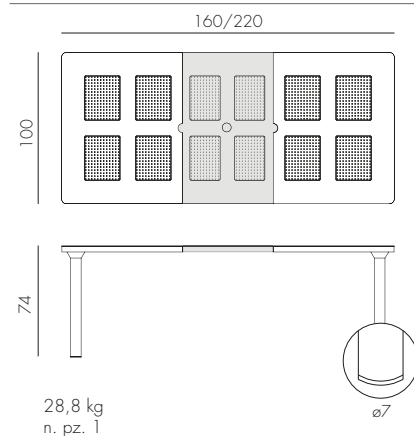

BIANCO  
verniciato bianco  
47553.00.000

ANTRACITE \*  
verniciato antracite  
47552.02.000

CAFFÈ \*  
verniciato caffè  
47557.05.000

TORTORA  
verniciato tortora  
47559.10.000

## LEVANTE 6/8

durelTOP - polipropilene  
alluminio

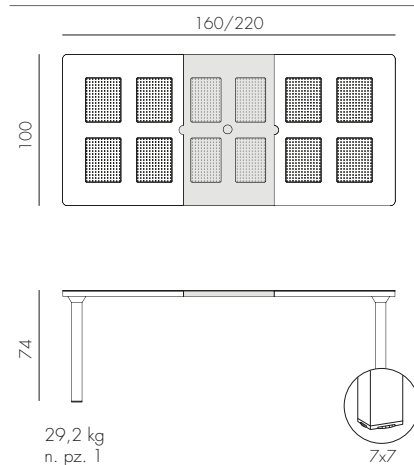

BIANCO  
verniciato bianco  
47053.00.000

ANTRACITE \*  
verniciato antracite  
47052.02.000

CAFFÈ \*  
verniciato caffè  
47057.05.000

TORTORA  
verniciato tortora  
47059.10.000

## MAESTRALE 220 6/8

durelTOP - polipropilene  
alluminio

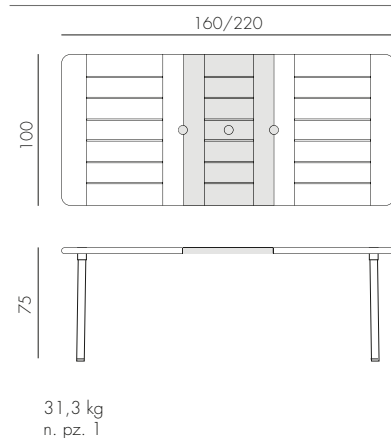

ANTRACITE \*  
verniciato antracite  
42252.02.000

TORTORA  
verniciato tortora  
42259.10.000

## MAESTRALE 90

durelTOP - polipropilene  
alluminio

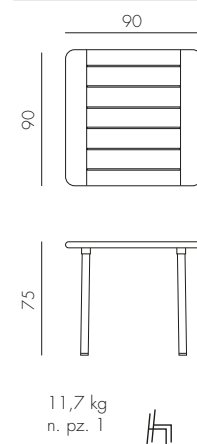

ANTRACITE \*  
verniciato antracite  
42052.02.000

TORTORA  
verniciato tortora  
42059.10.000

## STEP

polipropilene fiberglass

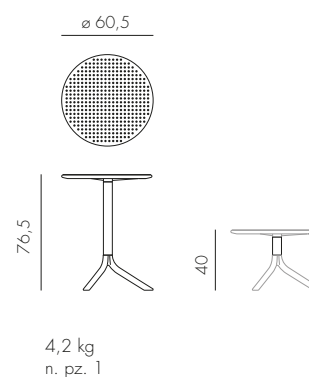

BIANCO  
40056.00.000

ANTRACITE  
40056.02.000

CAFFÈ  
40056.05.000

ROSSO  
40056.07.000

TORTORA  
40056.10.000

AGAVE  
40056.16.000

CELESTE  
40056.39.000

## SPRITZ

polipropilene fiberglass

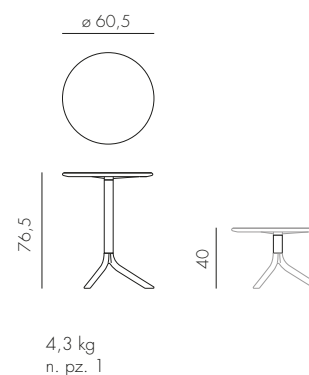

BIANCO  
40058.00.000

ANTRACITE  
40058.02.000

CAFFÈ  
40058.05.000

ROSSO  
40058.07.000

TORTORA  
40058.10.000

AGAVE  
40058.16.000

CELESTE  
40058.39.000

\* Posizionare in zona d'ombra - Only use table tops in shaded areas - Plateaux qui doivent être utilisés uniquement dans des zones ombragées - Tischplatten nur für beschatteten Einsatzbereich - Utilizar estos tableros sólo en áreas sombreadas - Colocar em local sombreado - Gölge alana koyun - Ставить в тени

\* Posizionare in zona d'ombra - Only use table tops in shaded areas - Plateaux qui doivent être utilisés uniquement dans des zones ombragées - Tischplatten nur für beschatteten Einsatzbereich - Utilizar estos tableros sólo en áreas sombreadas - Colocar em local sombreado - Gölge alana koyun - Ставить в тени



**materiali**  
**materials**



## polipropilene

Polipropilene trattato anti-UV e colorato in massa. Riciclabile al 100%.  
Polypropylene with UV additives and is uniformly colored. 100% Recyclable resin.  
Polypropylène traité anti-UV et coloré dans la masse. Résine recyclable 100%.  
UV-beständigem Polypropylen, voll durchgefärbt. 100% Recyclebarer Kunststoff.  
Polipropileno tratado anti UV y teñido en masa. Resina reciclable 100%.  
Polipropileno com tratamento anti-UV colorido na totalidade. Resina reciclável 100%.  
Işığa dayanıklı ve boyalı olarak granül çekilmiş %100 geri dönüşümlü polipropilen kompozit hammadde.  
Полипропилен с обработкой анти-УФ, окрашенное в массу. На 100% пригодно для вторичной переработки.

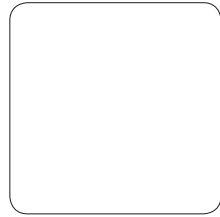

BIANCO .00



GRIGIO .03



ANTRACITE .02



TORTORA .10



CAFFE' .05



ROSSO .07



CELESTE .39



LIME .12



AGAVE .16

## durelTOP

DurelTOP è un sistema innovativo di produzione di piani per tavoli studiati per raggiungere i più elevati livelli di praticità, resistenza, robustezza ed eleganza. I piani DurelTOP sono ad alto spessore, formati da un doppio strato tamburato perfettamente chiuso. Prodotti in polipropilene di prima qualità, sono inalterabili all'acqua, resistenti al sole e facili da pulire. DurelTOP è il risultato di una lunga ricerca tecnologica e dell'esperienza decennale nella lavorazione delle materie plastiche della Nardi, da sempre all'avanguardia nell'ambiente contract e giardino.

The DurelTOP is an innovative new system in the production of tabletops developed to reach the highest levels of practicality, resistance, and elegance. The DurelTOP tabletops have a greater thickness, formed by a double layer enclosure perfectly closed. Produced in first quality polypropylene, they are resistant to water, resistant to sunlight, and are easy to clean. DurelTOP is a result of a decade's long research and development in plastics by Nardi, always a leader in the contract and garden sectors.

DurelTOP est un système innovateur de production de plateaux de tables, il est étudié pour retrouver le meilleur niveau de pratique de résistance et d'élégance. Les plateaux DurelTOP sont très épais, formés de doubles couches parfaitement finies. Ce sont des produits en polypropylène de première qualité, ils sont inaltérables à l'eau, résistent au soleil et faciles à nettoyer. DurelTOP est le résultat d'une longue recherche technologique et une expérience décennale dans le travail des matières plastique de la Sié Nardi, toujours à l'avant-garde dans le secteur du contract et jardin.

DurelTOP ist ein neu entwickeltes System für die Produktion von Tischplatten, um ein Höchstmaß an Funktionalität, Widerstandsfähigkeit und Eleganz zu erreichen. Durch das innen verstärkte "Zwei-Schichten-Hohlraum-System" erreicht die DurelTOP Tischplatte einen stärkeren Querschnitt und damit ein Höchstmaß an Festigkeit. Hergestellt aus hochwertigem Qualitätspolypropylen ist sie resistent gegen Wasser und Sonnenlicht und dabei leicht zu reinigen. DurelTOP ist das Ergebnis von 10 Jahren Forschung und Entwicklung auf dem Kunststoffsektor durch Nardi, immer der führende im Bereich Contract- und Gartenmöbel.

## polipropilene fiberglass

Polipropilene fiberglass trattato anti-UV e colorato in massa. Resina riciclabile al 100%.  
Uniformly colored fiberglass polypropylene resins with uv additives. 100% Recyclable resin.  
Polypropylène fiberglass traité anti-uv et coloré dans la masse. Résine recyclable 100%.  
UV-beständigem fiberglass Polypropylen, voll durchgefärbt. 100% Recyclebarer Kunststoff.  
Polipropileno fiberglass tratado anti UV y teñido en masa. Resina reciclable 100%.  
Polipropileno fiberglass com tratamento anti-UV colorido na totalidade. Resina reciclável 100%.  
Işığa dayanıklı ve boyalı olarak granül çekilmiş %100 geri dönüşümlü cam elyaf katkılı polipropilen kompozit hammadde.  
Полипропилен фиброволокно с обработкой анти-УФ, окрашенное в массу. На 100% пригодно для вторичной переработки.



DurelTOP es un nuevo sistema de fabricación de tableros de mesa estudiado para alcanzar los mas altos niveles de practicidad, resistencia, robustez y elegancia. Los tableros DurelTOP de gran solidez, estan formados por una doble capa perfectamente unida y sellada. Fabricados en polipropileno de primera calidad son inalterables al agua, resistentes al sol y de fácil limpieza. DurelTOP es el resultado de una prolongada investigación tecnológica y de la experiencia acumulada en los mas de diez años que Nardi lleva produciendo materias plasticas, siempre innovando en ambientes contract y jardín.

DurelTOP é um sistema de inovação da produção de tampos de mesa concebidos para atingir a máxima resistência,práticos e elegantes. Os tampos de mesa DurelTOP são formados poruma camada dupla e perfeitamente unida. Produzidos em polipropileno de primeira qualidade, são resistentes ao sol e fáceis de limpar. DurelTOP é o resultado de uma longa investigação tecnológica em materiais plásticos da Nardi, leader em mobiliário de jardim.

DurelTOP, masa tablalarının üretiminde kullanılan yeni bir sistem olup, yüksek seviyede pratiklik, direnç ve de şıklık sunmak amacıyla geliştirilmiştir. DurelTOP masa tablaları fevkalade bir inceliğe sahip olup, kusursuz kapanan çift tabaka çevirme sistemiyle oluşturulmuştur. Nitelikli çamsakızından üretilmiş olup, suya ve güneş ışığına karşı dirençli ve temizlenmesi kolaydır. DurelTOP sistemini Contract ve de Bahçe sektöründe her zaman lider olan Nardi'nin uzun araştırmalarının sonucundan doğan, plastikte gelişim olarak adlandırabiliriz.

DurelTOP — это инновационная система производства столешниц, позволяющая изготавливать практичные, прочные, крепкие и элегантные столешницы. Столешницы DurelTOP обладают высокой плотностью и состоят из двойной панели с мелкопустотным заполнением, полностью закрытой. Изделия из полипропилен высокого качества устойчивы к воде, солнцу и просты в уходе. DurelTOP — это результат многолетних технологических исследований и десятилетнего опыта Nardi в обработке пластмасс, лидера в производстве садовой мебели и контрактном секторе.

## tessuto acrilico #



Fibra acrilica 100% tinto filo. Trattamento antimacchia, antimuffa. Solidità alla luce 5/8. Lavabile a 30°.  
100% yarn dyed acrylic. Dirt repellent and anti-mould treatment. 5/8 light fastness. Washable at 30°.  
100% fibre acrylique teintée en fils. Traitement anti-taches et anti-moisissure. Résistance à la lumière 5/8. Lavable à 30°.  
100% garngefärbtes Polyacryl Gewebe. Gegen Flecken und Schimmel Ausrüstung. Lichtechtheit 5/8. Waschbar bei 30°.

# Variazioni di colore sono da ritenersi standard e naturali nei tessuti acrilici tinto filo. Posizionare in zone d'ombra - Colour variations are to be considered standard and natural in yarn-dyed acrylic fabrics. Position in shaded areas - Les variations de couleur des tissus acryliques au fil teint sont standard et naturelles. Placer dans des zones ombragées - Farbveränderungen sind als Standard und in im Garn gefärbten Acrylgeweben als natürlich zu betrachten. In schattigen Bereichen aufstellen - Las variaciones de color



grigio .163  
240 gr/m<sup>2</sup>

100% hilo teñido acrílico. Protección antimanchas, antimoho. Solidez a la luz 5/8. Lavable a 30°.  
100% fibra acrílica tingida com fio. Tratamento antimancha e antimofa. Resistência à luz 5/8. Lavável a 30°.  
%100 akrilik elyaf boyalı iplik. Leke itici, küf önleyici ile muamele edilmiş. Işık haslığı 5/8. 30°de yıkanabilir.  
Акриловое волокно 100% окрашенное в пряже. Пятноустойчивая и противогрибковая обработка. Светостойкость 5/8. Стирать при 30°.

son normales y naturales en las telas acrílicas teñidas en hilo. Colocar en zonas de sombra - As variações de cor são consideradas standard e naturais nos tecidos acrílico tingidos com fio. Posicionar em zonas de sombra - Boyalı akrilik iplik kumaşlarda renk değişiklikleri standart ve doğal kabul edilir. Gölge alanlara yerleştiriniz - Изменения цвета следует считать нормой, они являются естественными в случае акриловых тканей с окрашенными волокнами. Размещать в тени.

## tessuto acrilico Sunbrella®



100% fibra acrilica Sunbrella® tinto in massa. Trattamento idrorepellente, antimacchia, antimuffa. Solidità alla luce 8/8. Lavabile a 40°.  
100% Sunbrella® acrylic fiber mass dyed. Water repellent treatment, dirt repellent and anti-mould treatment. 8/8 light fastness. Washable at 40°.  
100% fibre acrylique Sunbrella® teintée en masse. Traitement imperméable, anti-taches et anti-moisissure. Résistance à la lumière 8/8. Lavable à 40°.  
100% fasergefärbtes Sunbrella® Polyacryl. Wasserabweisend Ausrüstung, gegen Flecken und Schimmel ausgerüstet. Lichtechtheit 8/8. Waschbar bei 40°.

100% fibra acrílica Sunbrella® tintada en masa. Tratamiento por la repelencia al agua, protección antimanchas, antimoho. Solidez a la luz 8/8. Lavable a 40°.  
100% fibra acrílica Sunbrella® tingida em massa. Tratamento hidrorrepelente, antimancha e antimofa. Resistência à luz 8/8. Lavável a 40°.  
%100 akrilik elyaf Sunbrella® çözelti halindeyken boyanmış. Su itici, leke itici, küf önleyici ile muamele edilmiş. Işık haslığı 8/8. 40°de yıkanabilir.  
100% акриловое волокно Sunbrella®, окрашенное в массу. Водоотталкивающая, пятноустойчивая и противогрибковая обработка. Светостойкость 8/8. Стирать при 40°.



grigio Sunbrella® .136  
275 gr/m<sup>2</sup>



## tessuto 100% Olefin



100% Olefin tinto in massa. Trattamento antimacchia, antimuffa. Solidità alla luce 7/8. Lavabile a 40°.  
100% Olefin mass dyed. Dirt repellent and anti-mould treatment. 7/8 light fastness. Washable at 40°.  
100% Olefin teintée en masse. Traitement anti-taches et anti-moisissure. Résistance à la lumière 7/8. Lavable à 40°.  
100% fasergefärbtes Olefin. Gegen Flecken und Schimmel Ausrüstung. Lichtechtheit 7/8. Waschbar bei 40°.

100% Olefin tintada en masa. Protección antimanchas, antimoho. Solidez a la luz 7/8. Lavable a 40°.  
100% Olefin tingida em massa. Tratamento antimancha e antimoho. Resistência à luz 7/8. Lavável a 40°.  
%100 Olefin çözelti halindeyken boyanmış. Leke itici, küf önleyici ile muamele edilmiş. Işık haslığı 7/8. 40°de yıkanabilir.  
100% Olefin, окрашенный в массе. Пятноустойчивая и противоплесневая обработка. Светостойкость 7/8. Стирать при 40°.



bianco .155  
190 gr/m<sup>2</sup>



caffè .165  
190 gr/m<sup>2</sup>

## imbottitura cuscino darsena - acquamarina

Poliuretano espanso. Densità 28 kg/m<sup>3</sup>. Polyurethane foam. Density 28 kg/m<sup>3</sup>. Mousse polyuréthane. Densité 28 kg/m<sup>3</sup>. Polyurethanschaum. Dichte 28 kg/m<sup>3</sup>.

Espuma de poliuretano. Densidad 28 kg/m<sup>3</sup>. Espuma de poliuretano. Densidade 28 kg/m<sup>3</sup>. Poliüretan köpük. Yoğunluk 28 kg/m<sup>3</sup>. Пенополиуретан. Плотность 28 кг/м<sup>3</sup>.

## tessuto sintetico

Tessuto in filo di poliestere rivestito in pvc. Fabric is made of a polyester fiber, with a pvc coating. Tissu en fil de polyester revêtu de pvc. Gewebe aus PVC-ummantelten Polyesterfasern.

Tejido en hilo de poliéster recubierto de pvc. Tecido de fibra polyester com cobertura pvc. PVC kaplı polyester elyaf tekstil. Ткань из полиэфирных нитей с покрытием из ПВХ.

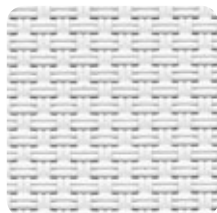

bianco .108  
tela 2x2



beige .115  
tela 2x2



tortora .124  
tela 2x2

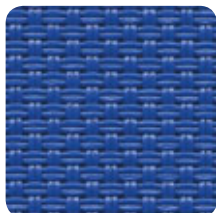

blu .112  
tela 2x2

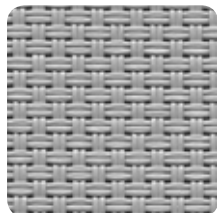

grigio .086  
tela 2x2



trama caffè .117

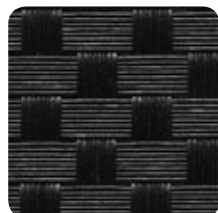

trama antracite .116

## alluminio verniciato

La verniciatura è a polvere di poliestere. The painting is with polyester powder. La peinture est à poudre de polyester. Die Epoxierung erfolgt mit Polyesterpulver. El pintado

se realiza con polvo de poliéster. O pó de poliéster é usado para envernizar. Boyası polyester tozla yapılır. Окразка производится при помощи порошкового полиэстера.

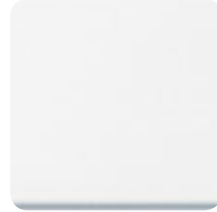

verniciato bianco .53



verniciato antracite .52



verniciato tortora .59



verniciato caffè .57



impilabile stackable empilable stapelbar apilable empilhável istiflenebilir стекируемые



impilabile orizzontalmente stackable horizontally piètement encastrable Ineinander stapelbar apilable horizontalmente empilhável horizontalmente yatay olarak istiflenebilir горизонтальная расстановка



pieghevole folding pliant klappbar plegable dobrável katlanabilir складывающийся



reclinabile reclining dossier réglable verstellbare Rückenlehne reclinable reclinável sırt pozisyonlu откидной

Tutte le sedute sono dotate di piedini antiscivolo. All chairs are equipped with non-slip feet. Tous les sièges sont équipés avec patins anti-dérapants.

Alle Stühle sind mit rutschfesten Fußkappen ausgestattet. Todos los asientos están equipados con tapones antideslizantes. Todos os assentos estão equipados com pés antiderrapantes. Bütün sandalyeler kaymaz ayaklıdır. Ножки всех стульев оснащены противоскользящей резиновой подложкой.

Sui colori scuri, ombre ed altri difetti minori sono più evidenti rispetto ai colori chiari e sono da ritenersi standard. On dark colors, shadows and other minor faults are more evident than on lighter colors and are therefore standard. Sur les couleurs sombres, les ombres et les autres petits défauts sont plus marqués que sur les couleurs claires et sont tout à fait standards. Auf dunklen Farben sind Schatten und andere kleinere Mängel sichtbar als auf hellen Farben und sind daher als Standard zu betrachten. Las sombras y demás defectos menores son más evidentes sobre los colores oscuros respecto a los colores claros y tienen que considerarse como estándares. Em cores escuras, sombras e outros defeitos menores são mais evidentes do que em cores claras e devem ser considerados standard. Koyu renkler üzerinde, gölgeler ve diğer küçük defolar açık renkler üzerinde olduklarından daha belirginleşmekte ve bu nedenle normal olarak değerlendirilmelidirler. По сравнению со светлыми цветами на темных цветах тени и другие небольшие дефекты более заметны и должны считаться нормой.

Il peso (kg), le misure (cm) e i colori riportati sono indicativi. La NARDI si riserva il diritto di apportare modifiche o varianti senza preavviso. Tutti i modelli sono depositati. Weights (kg), dimensions (cm) and colors are indicative only. NARDI reserves the right to make changes or variations without notice. All models are patented. Le poids (kg), les dimensions (cm) et les coloris indiqués sont fournis purement à titre indicatif. La Firma NARDI se réserve le droit d'apporter toute modification ou variation sans aucun préavis. Tous les modèles sont déposés. Alle Farb-, Maß- (cm) und Gewichtsangaben (kg) sind nicht als fest bindend anzusehen Firma NARDI behält sich das Recht von Änderungen Alle Modelle sind gesetzlich geschützt. El peso (kg), las medidas (cm) y los colores detallados, son indicativos. La firma NARDI se reserva el derecho de modificaciones o variaciones sin previo aviso. Todos los modelos llevan nuestra marca. O peso (kg), as medidas (cm) e as cores indicadas, são indicativos. A NARDI reservase o direito de aportar modificações ou variações sem pré-aviso. Todos os modelos estão depositados. Ağırlık (kg), boyutlar (cm) ve renkler gösterme amaçlıdır. NARDI'nin önceden bildirmeden değişiklik yapma hakkı vardır. Bütün modeller patentlidir. Приведенный вес (кг), размеры (см) и цвета являются ориентировочными. Компания NARDI оставляет за собой права вносить изменения и вариации без предварительного предупреждения. Все модели зарегистрированы.





1138 Budapest, Váci út  
144-150.(Váci Corner)  
Tel. +36 1 611 7646  
Fax . +36 1 611 7647  
Mobil. +36 30 985 9283  
Email. budapest@vivax.hu

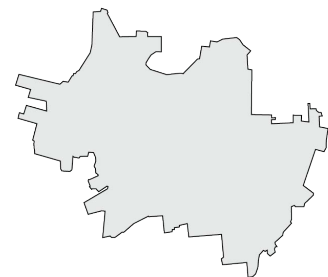

4031 Debrecen, István utca 6.  
Tel. +36 52 524 540  
Fax. +36 52 524 541  
Mobil. +36 70 671 0377  
Email. vivax@vivax.hu,  
tervezes@vivax.hu

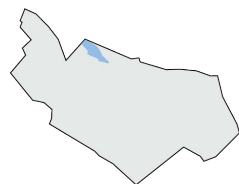

2045 Törökbálint, Tópark utca 1/a.  
(MaxCity Lakberendezési  
Áruház, II. em. 232.)  
Tel . +36 23 444 707  
Fax . +36 23 444 708  
Mobil. +36 30 968 5232  
Email. budapest@vivax.hu

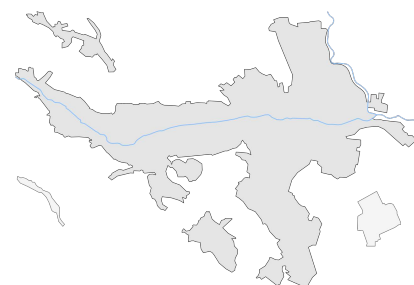

3525 Miskolc, Széchenyi utca 99.  
Tel. +36 46 413 920  
Fax. +36 46 413 921  
Mobil. +36 30 903 9255  
Email. vivaxmiskolc@vivax.hu



10101113