

NARDI
YOUR OUTDOOR LIVING

vivax

contract

design Raffaello Galotto

Arredi per l'outdoor
in resina fiber-glass studiati per il well-being delle persone.
Design, studio dei colori, eccellenza produttiva totalmente Made in Italy.
Attenzione all'ambiente nei cicli industriali, nella riciclabilità dei prodotti
e riutilizzo degli scarti, nell'ideazione di packaging eco-compatibili.
Ampia gamma di prodotti, misure e colori disponibili a catalogo
per arredi apprezzati dai progettisti di tutto il mondo.

*Outdoor furnishings
in fiberglass resin designed for people's well-being.
We bring together unique designs with the study of colours,
the manufacturing excellence of a product entirely created Made in Italy.
Great attention to the environment when it comes to the industrial cycles,
recycling products, reusing scraps and creating eco-compatible packaging.
A wide range of products, sizes and colours available in the furnishing catalogue
appreciated by project designers the world over.*

index

8	folio
20	komodo
38	trill bistrot
40	trill armchair
42	trill stool
48	net bench
52	net relax
54	net
60	bit
62	net stool
64	net table
70	bora
72	riva
74	costa
80	darsena
82	acquamarina
84	lido
86	faro
90	aria
98	palma
100	erica
102	gardenia • dalia
106	loto • ninfea
112	dama
114	regina
115	duca
118	frasca
126	clip
130	step • spritz
134	fiore
136	ibisco
138	flute • break
140	scudo
144	cube
150	atlantico • pop
158	alfa • omega
163	regeneration
166	sipario
176	komodo ecowall
181	technical details



Folio

FOLIO - FOLIO ROCKING - POGGIO



FOLIO
agave



FOLIO
agave





FOLIO
agave



FOLIO

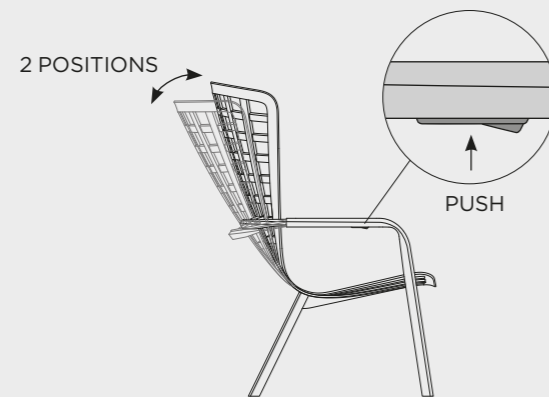

FOLIO ROCKING

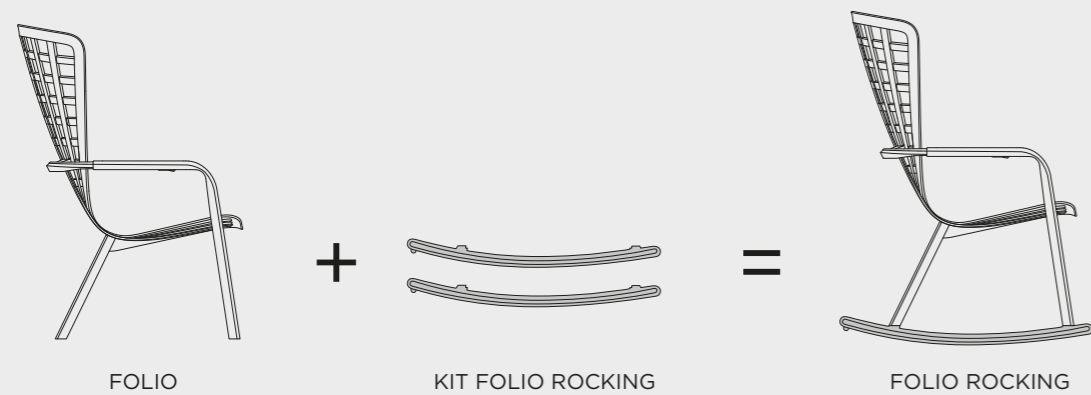

FOLIO è una innovativa poltrona relax a due posizioni pensata per l'outdoor, proposta su base fissa, con poggiatesta, oppure nella romantica versione a dondolo. L'ampia scocca della poltrona è costituita da un unico foglio dal design sapientemente curvato in modo da permettere il movimento tra seduta e schienale sfruttando l'elasticità del materiale senza l'ausilio di elementi di congiunzione o di rotazione.

FOLIO is an innovative relaxing armchair, adjusting to two positions, designed for outdoor use. It is available with a fixed base and a footrest, or in a romantic rocking version. The large structure of the armchair is made from a single perforated sheet. It has an expertly curved design that allows movement between the seat and back, exploiting the flexibility of the material without requiring any linking or rotating elements.



FOLIO ROCKING
agave/artic



FOLIO ROCKING
tabacco/felce



FOLIO
agave/artic
FOLIO ROCKING
bianco/lino - antracite/rosa quarzo



FOLIO
agave
POGGIO
agave



POGGIO
agave



POGGIO
tabacco - antracite - agave



Komodo

SISTEMA MODULARE DI SEDUTE
modular system of upholstered seats



GOOD DESIGN
AWARD 2019
winner



GERMAN
DESIGN
AWARD
WINNER
2020

KOMODO 5
tortora/rosa quarzo



KOMODO POUF
KOMODO ELEMENTO TERMINALE
tortora/rosa quarzo

KOMODO ELEMENTO CENTRALE
KOMODO ELEMENTO ANGOLO
tortora/rosa quarzo

KOMODO

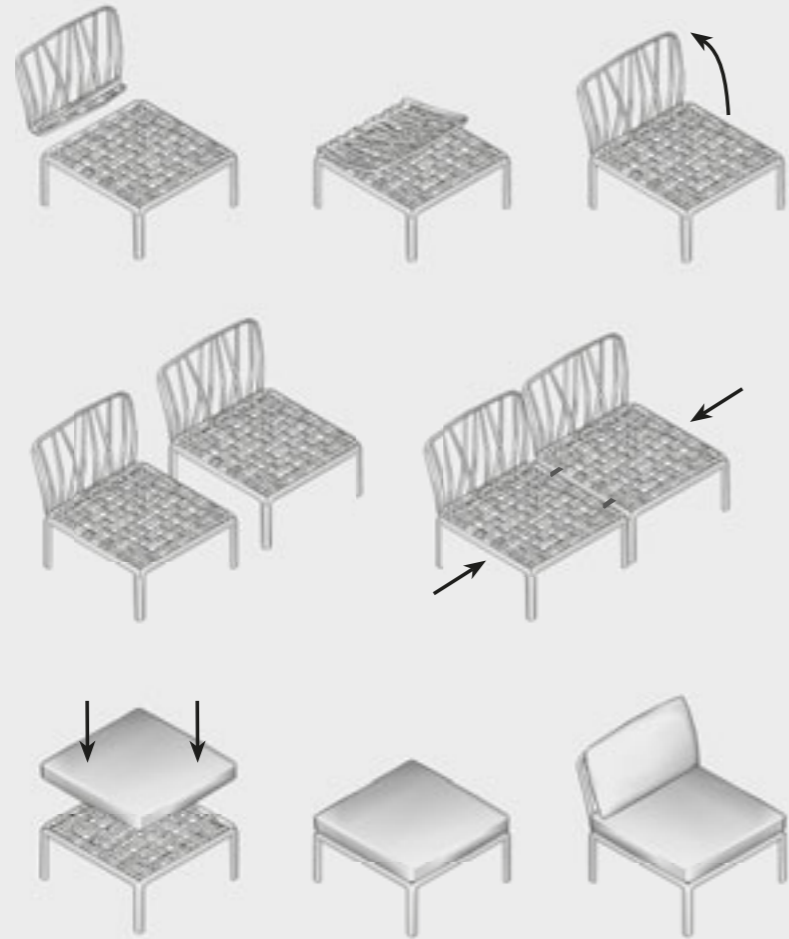

KOMODO è un sistema modulare di sedute configurabile a piacere. I moduli possono essere fissati tra loro e gli schienali e i braccioli sono agganciabili su tutti i lati della seduta. Oltre alla versione standard KOMODO 5, è possibile configurare e ordinare la tua versione personalizzata elencando tutti i singoli elementi che la formano.

KOMODO is a modular system of upholstered seats which can be configured to suit your particular needs. The modules can be secured to one another and the backrests and armrests can be attached on all sides of the seat.

In addition to the standard KOMODO 5 version, you can configure and order your own customized version simply by listing all the individual elements you require.



KOMODO POLTRONA
tortora/rosa quarzo



KOMODO
agave/avocado



KOMODO
agave/avocado - giungla



KOMODO
bianco/ghiaccio - adriatic



KOMODO
bianco/adriatic



KOMODO
bianco/adriatic



KOMODO TAVOLINO
antracite



KOMODO TAVOLINO VETRO
antracite/vetro
KOMODO
antracite/grigio



KOMODO POUF
bianco/adriatic - tortora/rosa quarzo - antracite/canvas - grigio



KOMODO POUF
bianco/canvas



KOMODO
Riva Event 2019 (Ferretti Group) - Venice - Italy



KOMODO
Borgo Aratico - Monopoli - Italia



KOMODO
Loop hotel - Vilnius - Lithuania





Trill Bistrot



TRILL BISTROT
senape



TRILL BISTROT
ottanio



TRILL BISTROT
senape

Trill Armchair



TRILL ARMCHAIR
rosa bouquet
FRASCA MINI FIX
tortora - piano Laminato 70x70 tortora



TRILL ARMCHAIR
rosa bouquet



TRILL ARMCHAIR
grigio

Trill Stool



TRILL STOOL - TRILL STOOL MINI
agave



TRILL STOOL
tabacco
FIORE HIGH
bianco



TRILL STOOL
agave



TRILL BISTROT - RIO
The Real Estate of Petroio - Tuscany - Italy



TRILL - IBISCO
Papillon Wine Bar - Thiene - Italy



TRILL - CLIP
15.16 Birroteca e Oltre - Arzignano - Italy



Net Bench



NET BENCH
antracite - senape
CUSCINO NET BENCH
grigio



NET BENCH
senape
CUSCINO NET BENCH
denim



NET BENCH
salice/the verde
NET TABLE 100
salice



NET BENCH - NET RELAX - NET TABLE 100
tortora
CUSCINI NET BENCH - NET RELAX - SHELL
denim

Net relax



NET RELAX
bianco - tortora
CUSCINO NET RELAX
rosa quarzo



GOOD DESIGN
AWARD 2018
winner



reddot award 2018
winner



selected by
ADI DESIGN
INDEX 2017



NET RELAX
antracite
CUSCINI NET RELAX - SHELL
rosa quarzo



Net



NET - FIORE
tortora



NET
corallo - bianco - antracite
CUSCINO NET
rosa quarzo - bianco - grigio



NET
antracite



NET - SPRITZ
A Roma - Porec - Croatia



NET - SCUDO
Madliena Lodge - Swieqi - Malta

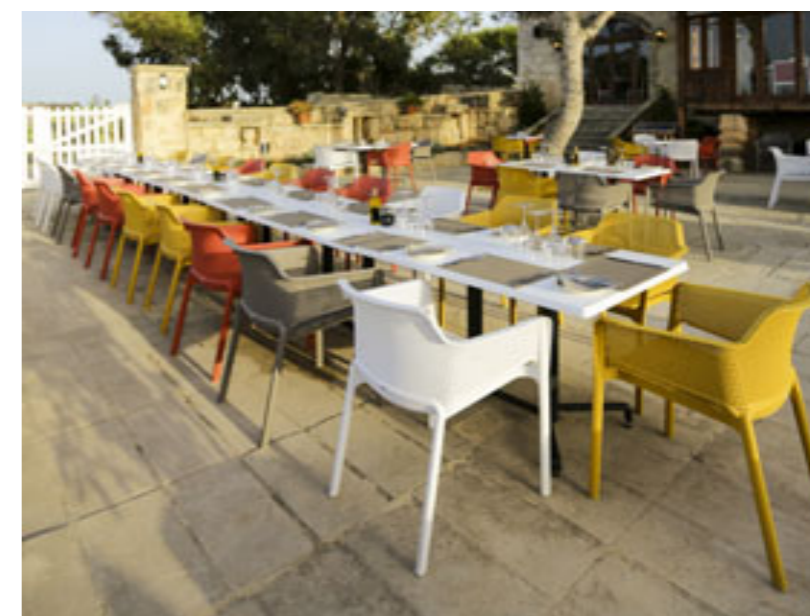



ph. Michael Condran



ph. Michael Condran

NET RELAX - SPRITZ
Skylark Negril Beach Resort - Negril - Jamaica



NET RELAX
Moncastro Hotel - Odessa - Ukraine

Bit



BIT - BREAK
antracite

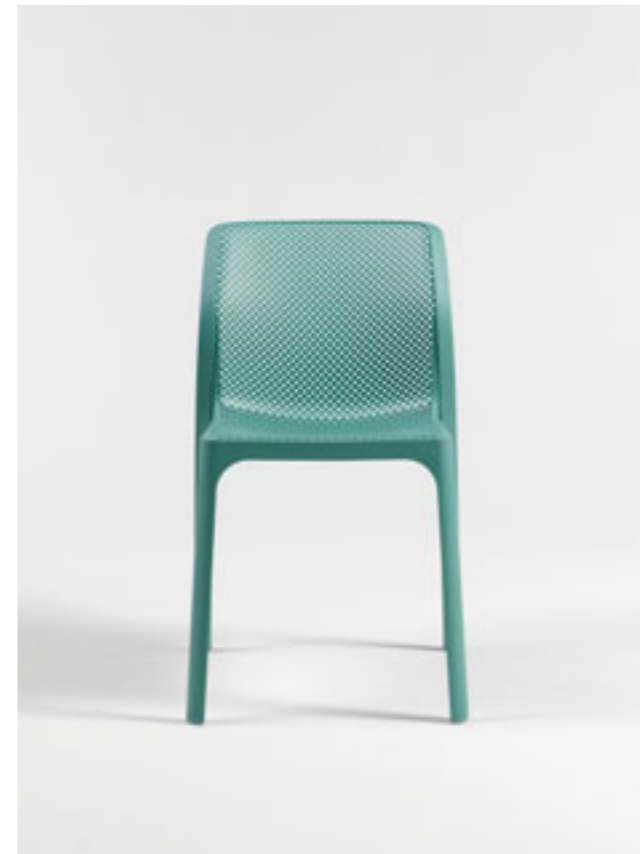

BIT
salice

Net Stool



NET STOOL MINI - NET STOOL
tortora



NET STOOL
tortora



NET STOOL
senape

Net Table

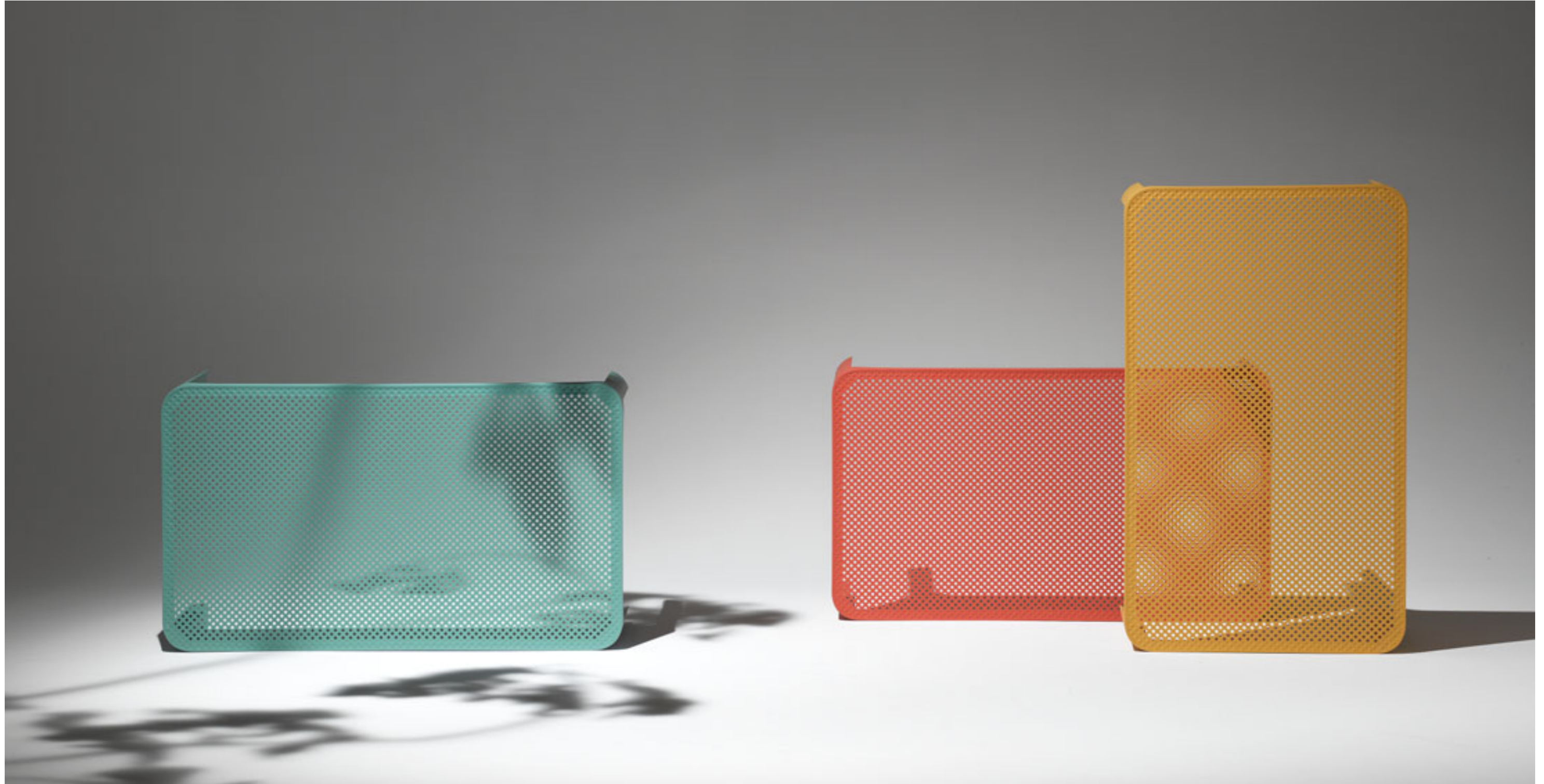



NET TABLE 100 - NET BENCH
bianco



NET TABLE 100
tortora



NET TABLE 100
antracite





Bora



BORA
rosso



BORA - CLIP 70
tortora



BORA BISTROT
tortora



Riva



RIVA BISTROT - SPRITZ
agave



RIVA - FIORE
bianco



Costa



COSTA
antracite



COSTA BISTROT
antracite



COSTA
bianco



ph. Benedetto Tarantino



ph. Cristiano Cardoso



ph. Benedetto Tarantino



ph. Cristiano Cardoso

BORA BISTROT - LIDO
Gran Caffè Torino - Palermo - Sicily - Italy

BORA
Vineria 1976 - Porto Alegre - Brasil



ph. Michael Condran

BORA BISTROT
Skylark Negril Beach Resort - Negril - Jamaica



COSTA
Vicenza - Italy



BORA - BORA BISTROT
Mulino Caffè - Vicenza - Italy



RIVA BISTROT
IAAD - Torino - Italy



FARO - COSTA BISTROT
Le Chicche - Vicenza - Italy

Darsena



DARSENA
antracite



DARSENA
antracite



Acquamarina



ACQUAMARINA
bianco
STEP
bianco



ACQUAMARINA
tortora

Lido



LIDO
rosso



LIDO - LIDO MINI
tortora



Faro



FARO
antracite



FARO
antracite



FARO
tortora
FIORE HIGH
bianco



Aria



ARIA FIT
tortora/bianco



ARIA FIT
tortora/grigio
FIORÉ
tortora



ARIA FIT
tortora/bianco



ARIA POLTRONA
bianco/sardinia - cherry - lime
ARIA TAVOLINO 60
bianco



ARIA POLTRONA
tortora/caffè
ARIA TAVOLINO 100
tortora



ARIA
Ammos Beach Bar
Kos - Greece



ARIA
Maris Suites - Zante - Greece



ARIA
Showroom ALU B.V.
Amsterdam - Netherlands



ARIA
Nira Montana - La Thuile - Italy



Palma



PALMA
bianco/tortora



PALMA - CUBE 70
tortora



Erica



ERICA
antracite



ERICA
bianco



ERICA - CUBE 70
bianco

Gardenia • Dalia



GARDENIA
bianco/tortora



DALIA
tortora





Loto • Ninfea



NINFEA RELAX - LOTO RELAX 95
antracite



NINFEA RELAX
bianco



LOTO RELAX 95 - LOTO RELAX 60
bianco



NINFEA DINNER - FLUTE
antracite



NINFEA DINNER
antracite



NINFEA DINNER
bianco



Dama



DAMA
tortora - burro



DAMA
tortora



DAMA
tortora

Regina



REGINA
antracite

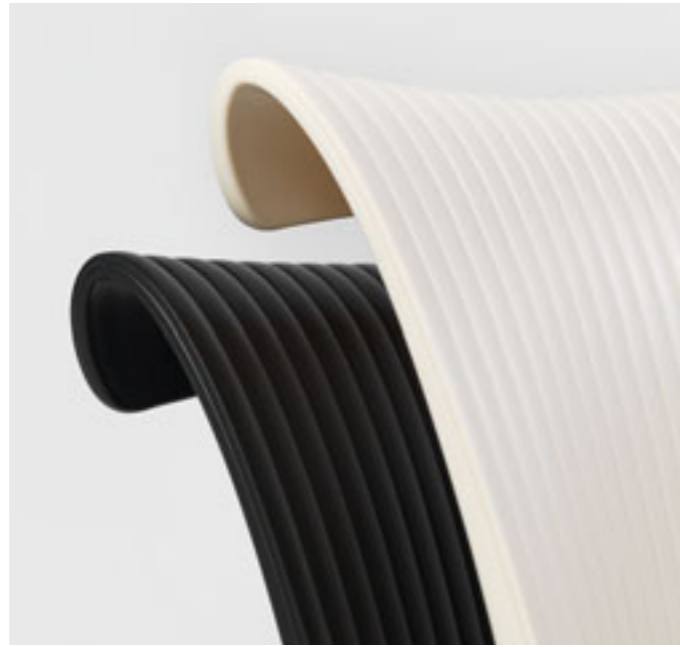

REGINA
antracite - burro



REGINA - CALICE
antracite

Duca



DUCA - SCUDO HIGH
tortora



Frasca





FRASCA MAXI FIX
agave - piano Laminato 90x90 agave
FRASCA MINI FOLDING
agave - piano Laminato 70x70 agave



FRASCA MINI
agave



FRASCA MINI FOLDING
 antracite - tortora - bianco - agave
 piani Laminato 70x70



FRASCA MINI FIX
 bianco - agave - antracite - tortora
 piani Laminato ø70



FRASCA MAXI FIX
agave - piano Laminato 90x90 agave
TRILL BISTROT
agave



FRASCA MAXI FIX
agave - piano Laminato 90x90 agave
TRILL BISTROT
agave

Clip



CLIP 80 - CLIP 70 - BORA
tortora



CLIP 80 - BORA
tortora

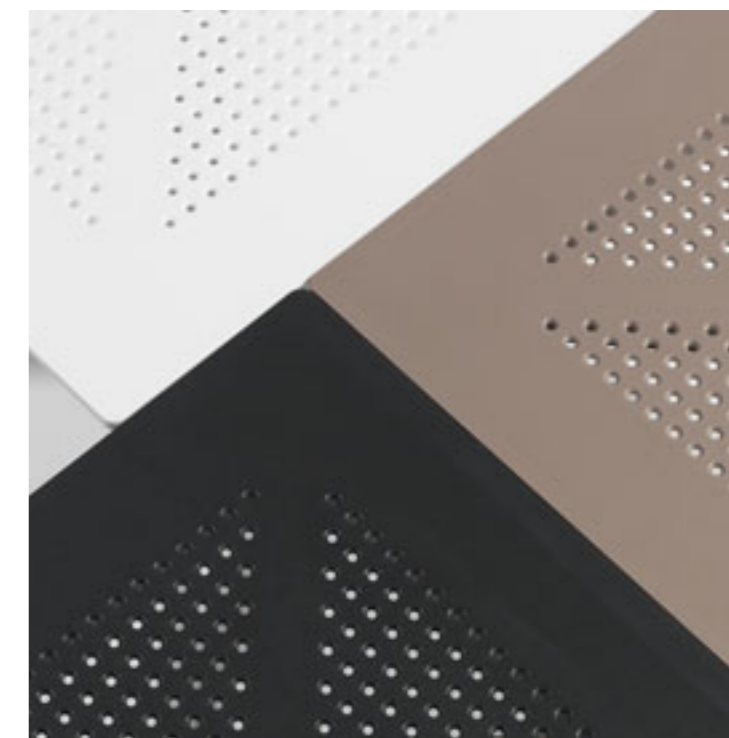

CLIP 70
bianco - antracite - tortora



CLIPX 80 - NET
tortora



BASE CLIP
bianco - piano Laminato 70x70 total white

Step • Spritz





STEP
rosso



STEP - BORA BISTROT
tortora



SPRITZ
antracite
SPRITZ MINI
tortora

Fiore



FIORE HIGH - FIORE
bianco - piano Laminato 70x70 total white
FARO - RIVA BISTROT
celeste



FIORE
bianco - piano Laminato 70x70 total white



Ibisco



IBISCO
tortora - piano Laminato 80x80 tortora



IBISCO HIGH
antracite - piano Laminato 70x70 antracite

Flute • Break



FLUTE
tortora
piano Laminato ø70 tortora



FLUTE
bianco - piano Laminato ø70 bianco



FLUTE
antracite - piano Laminato ø70 antracite



BREAK
bianco - piano Laminato ø70 bianco



BREAK
antracite - piano Laminato ø70 antracite

Scudo



SCUDO DOUBLE
antracite



SCUDO
tortora
piano Laminato 80x80 tortora



SCUDO - SCUDO HIGH
tortora
piano Laminato 70x70 tortora



Cube



CUBE 70
tortora



CUBE 80 - PALMA
tortora



CUBE 80 - 70 - 70 HIGH
tortora



CUBE 140x80
tortora



CUBE 140x80 - 140x80 HIGH
tortora



CUBE 140x80 HIGH
bianco
NET STOOL
bianco



Atlantico • Pop



ATLANTICO
tortora/deserto - tortora/agave



ATLANTICO - POP
antracite



POP
tortora



ATLANTICO
tortora/tortora



ATLANTICO
bianco/tortora



ATLANTICO
Ammos Beach Bar - Kos - Greece



ATLANTICO
Calheta Boutique Houses - Madera - Spain



ATLANTICO
Moncastro Hotel - Odessa - Ukraine



ATLANTICO - SPRITZ
Villa Aieni - Puglia - Italy



ph. Raffaele Mariniello



ph. Raffaele Mariniello



ph. Raffaele Mariniello

ATLANTICO
Laghi Nabi - Parco Benessere - Campania - Italy



ATLANTICO
Sunmelia Beach Resort Hotel & Spa - Antalya - Turkey

Alfa • Omega



OMEGA
grigio/grigio



ALFA
tortora/tortora

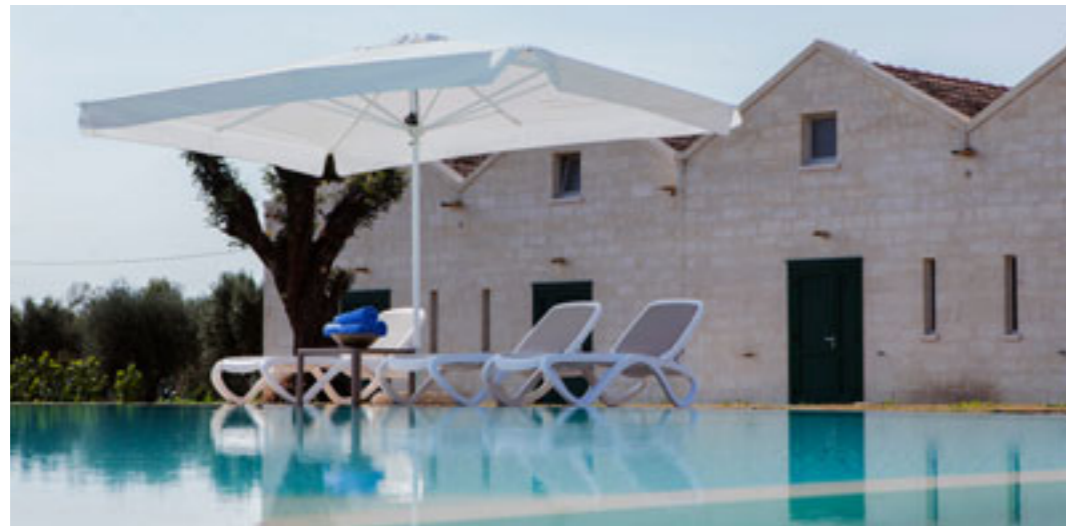

OMEGA
Agrumare Farm Holiday - Matera - Italy



OMEGA
Cave Bianche Hotel - Trapani - Italy

regeneration



I prodotti ritirati dal mercato hanno le seguenti caratteristiche:

- 100% POLIPROPILENE (PP);
- senza contaminazioni di altri materiali;
- prodotti di arredo conformi (tavoli, lettini e sedie)

Products recovered from the market have the following characteristics:

- 100% POLYPROPYLENE (PP);
- uncontaminated by other materials;
- compliant furniture products (tables, sunloungers and chairs)



La triturazione del prodotto ritirato, esente da metalli e contaminazioni, consente di ridurre gli oggetti in piccole parti. Il polipropilene triturato viene omogeneizzato e uniformato nel colore consentendo la realizzazione di nuovi prodotti a loro volta riciclabili

The shredding of recovered products, free from metals and contaminants, allows objects to be reduced to small parts. Shredded polypropylene is given a uniform colour, allowing new products to be created that can, in turn, be recycled



Il polipropilene rigenerato dà vita a nuovi prodotti in un'ottica di economia circolare. Con un prodotto rigenerato si riduce l'impiego di materia prima e di energia con evidenti benefici ambientali

Regenerated polypropylene can be used for new products based on the circular economy. A regenerated product involves a reduction in the use of raw materials and energy, with obvious advantages for the environment

regeneration

I prodotti in polipropilene Nardi sono riciclabili al 100% e possono, una volta rientrati in Azienda, dare vita a nuovi prodotti.

Nardi ha sempre riciclato tutti gli scarti di produzione; da qui l'idea di recuperare la plastica per rigenerarla. REGENERATION è un programma industriale per la rigenerazione della plastica usata messo a punto da Nardi, azienda specializzata nell'arredo outdoor e nella ricerca di nuove modalità del vivere bene all'aria aperta.

Nardi polypropylene products are 100% recyclable and when returned to the company, they can be used to create new products. Nardi has always recycled all its production waste and this led to the idea of recovering used plastic to regenerate it.

REGENERATION is an industrial programme to regenerate used plastic by Nardi, a company specialised in outdoor furniture and researching new ways of enjoying outdoor life.

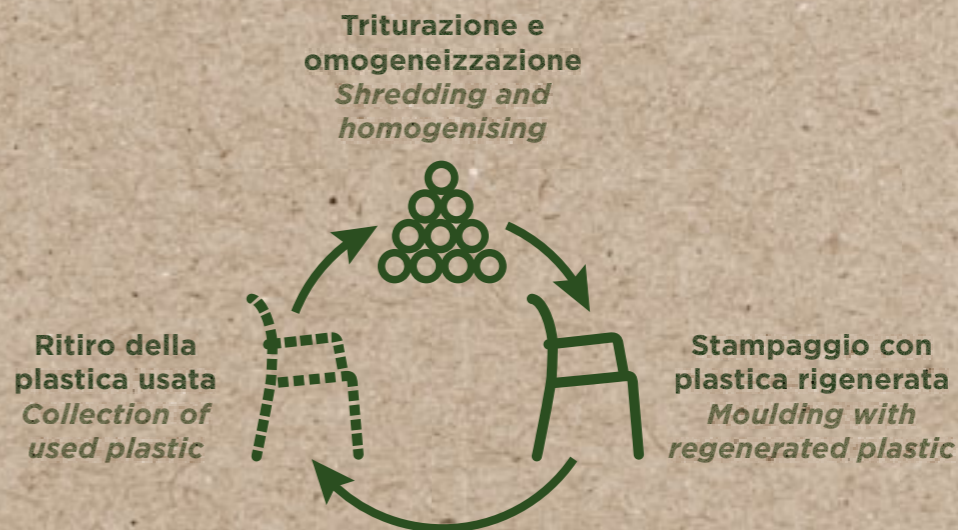

Sipario

ECO PARTITION



SIPARIO 2
TRILL BISTROT
senape
FRASCA MINI FIX
tortora



SIPARIO 3
TRILL BISTROT
senape
FRASCA MINI FIX
tortora



SIPARIO 3





ALCUNE POSSIBILI CONFIGURAZIONI
SOME POSSIBLE CONFIGURATIONS

FONDO DRENANTE
DRAINAGE BASE

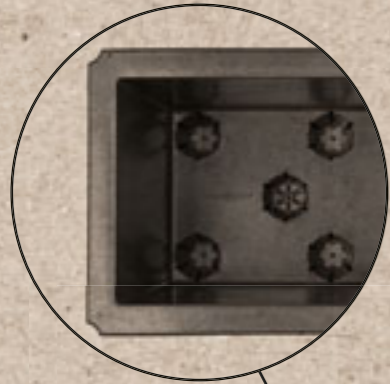

FORO DI RIEMPIMENTO SERBATOIO
HOLE FOR FILLING RESERVOIR

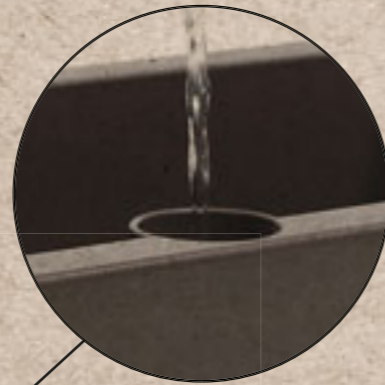

VASO AUTOIRRIGANTE
SELF-WATERING PLANTER

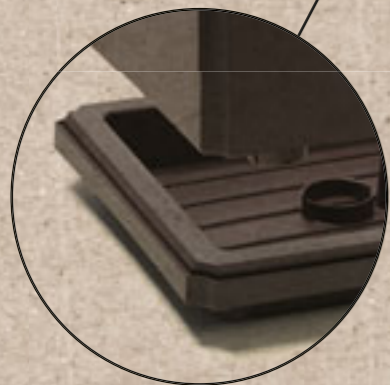

SOTTOVASO - SERBATOIO
PLANTER TRAY-RESERVOIR



MIN MAX
INDICATORE DI LIVELLO DELL'ACQUA
WATER LEVEL INDICATOR



SIPARIO

SIPARIO

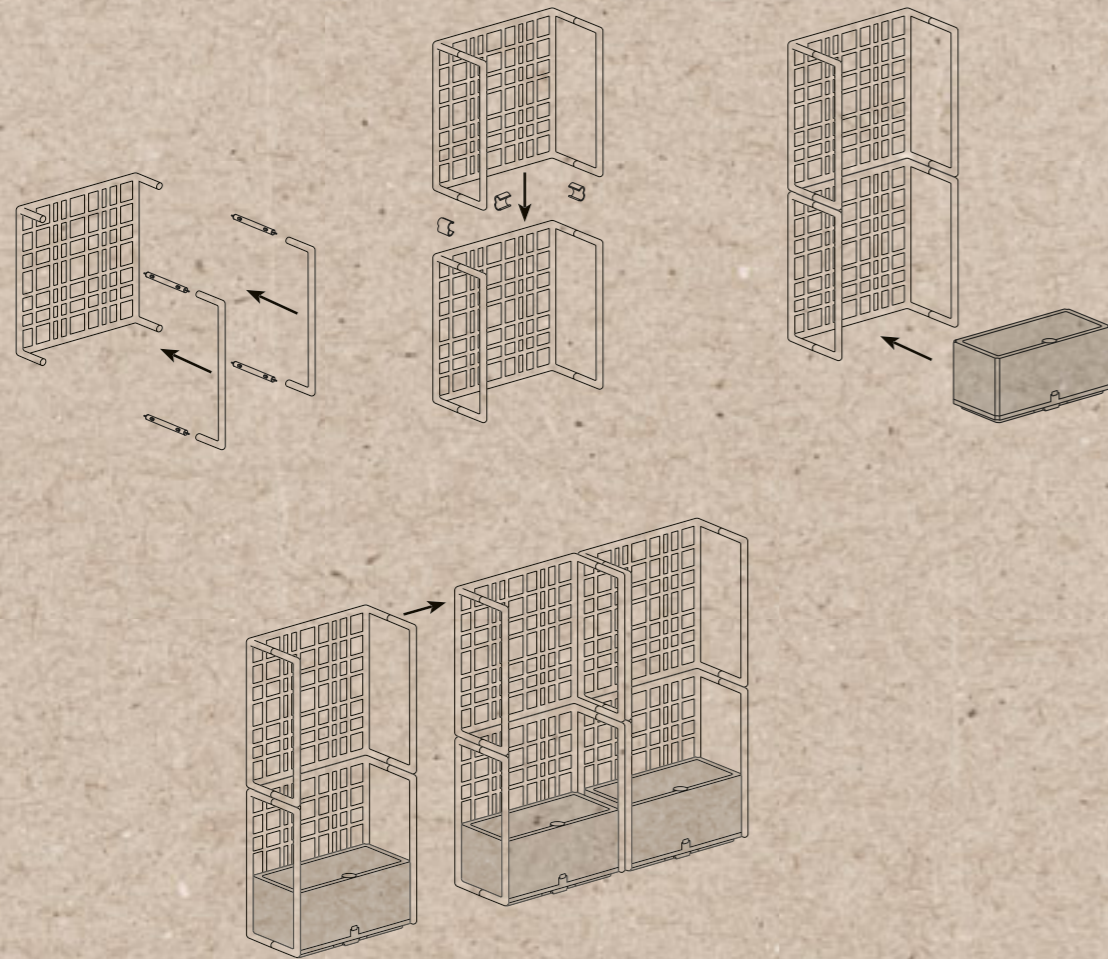

SIPARIO è un divisorio modulare autoportante da esterno configurabile a piacere, ideale per dividere gli spazi aperti. È costituito da elementi grigliati facilmente agganciabili tra loro senza l'uso di viti e dotato di vaso contenitore per piante. È realizzato in plastica rigenerata

SIPARIO, a free-standing modular partition for outdoor use, can be configured as required and is ideal for separating open spaces. It consists of grid elements, easily hooked together without using screws, and includes a container for plants. It's made of regenerated plastic

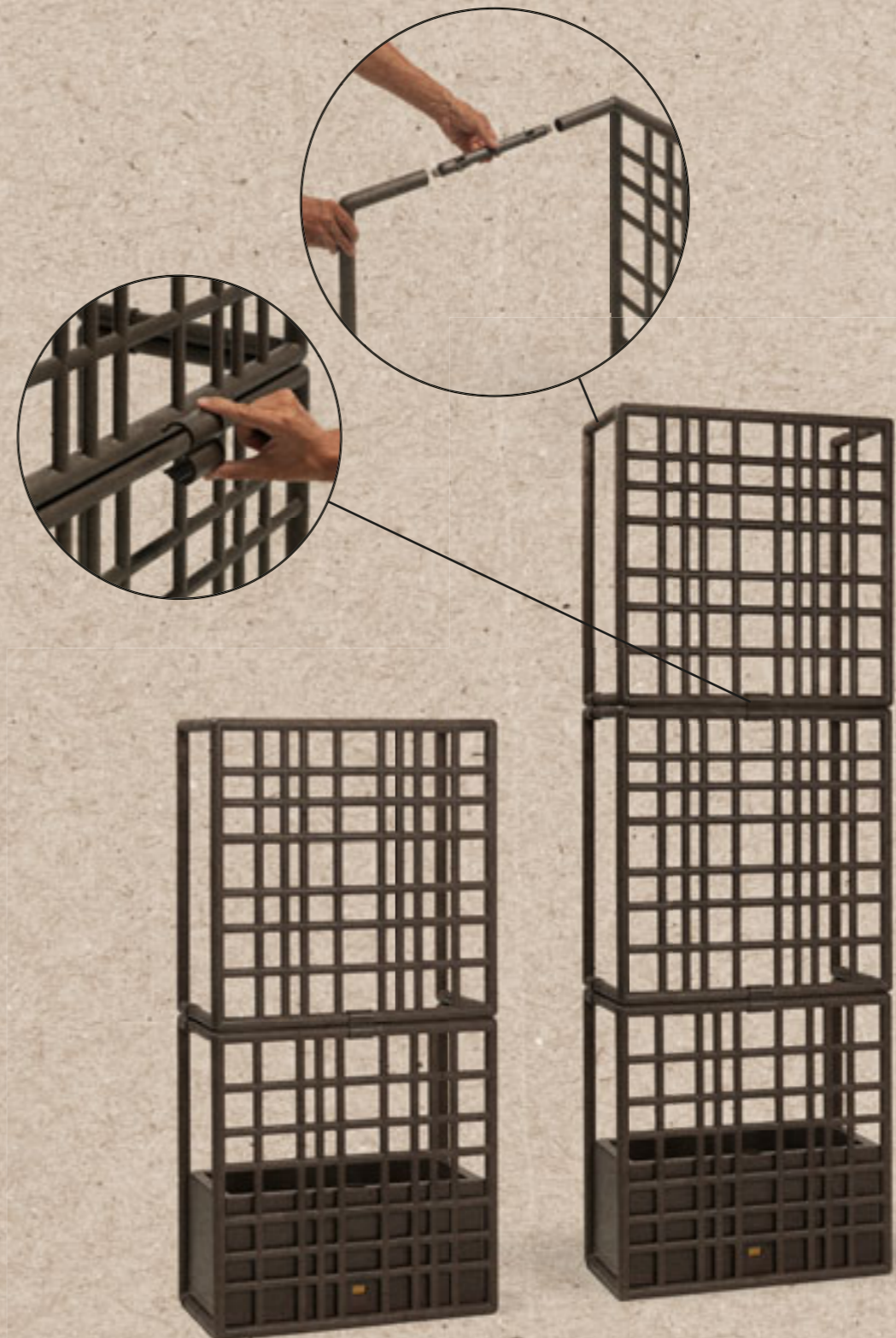

SIPARIO 2 - SIPARIO 3

Komodo EcoWall

ECO PARTITION



KOMODO ECOWALL
KOMODO
agave/avocado

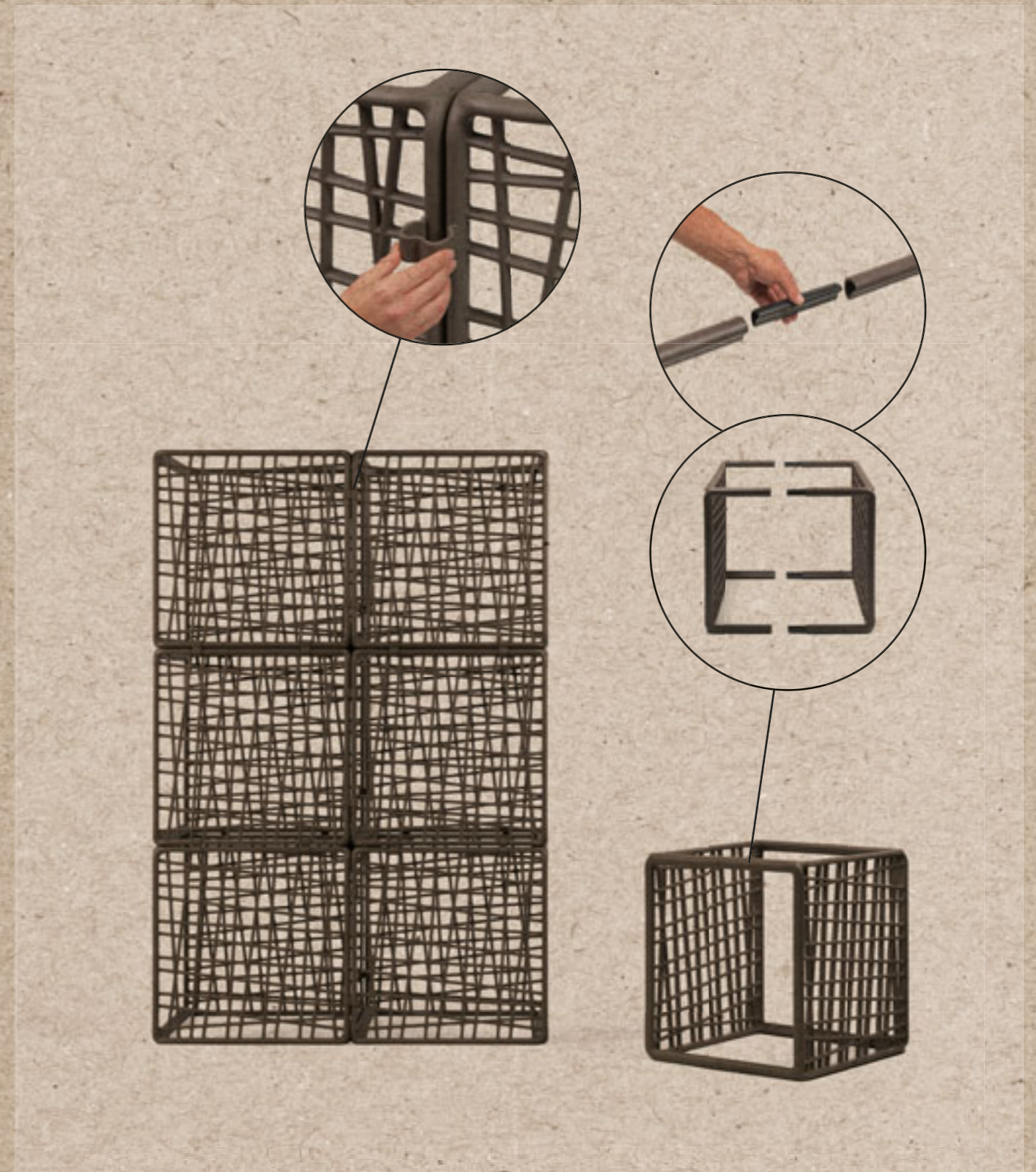

KOMODO ECOWALL



KOMODO ECOWALL - KOMODO
Università Statale di Milano - Milano - Italy



KOMODO ECOWALL - KOMODO
Papillon Wine Bar - Thiene - Italy

schede tecniche
technical details

FOLIO **new**

polipropilene fiberglass

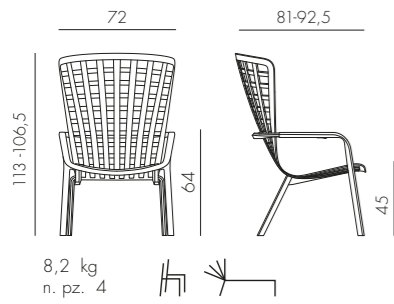

8,2 kg
n. pz. 4

KIT FOLIO ROCKING **new**

polipropilene fiberglass

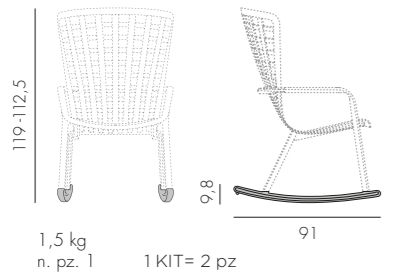

1,5 kg
n. pz. 1
1 KIT= 2 pz

POGGIO **new**

polipropilene fiberglass

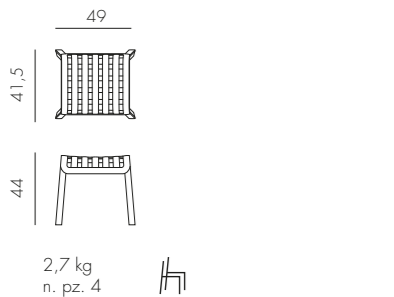

2,7 kg
n. pz. 4

CUSCINO FOLIO COMFORT **new**

tessuto

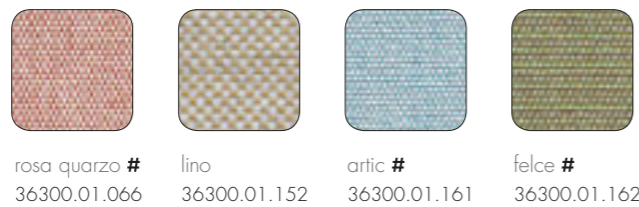
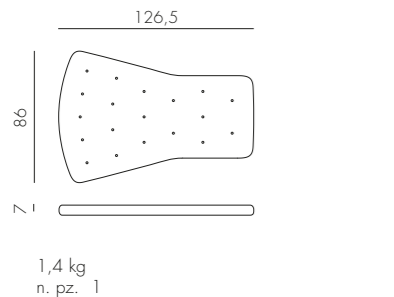

1,4 kg
n. pz. 1

KOMODO POLTRONA

polipropilene fiberglass
tessuto

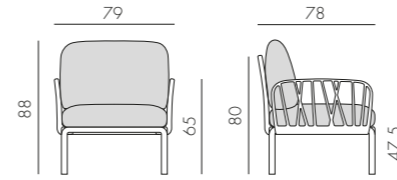

14,3 kg
n. pz. 1

KOMODO ELEMENTO TERMINALE DX/SX

polipropilene fiberglass
tessuto

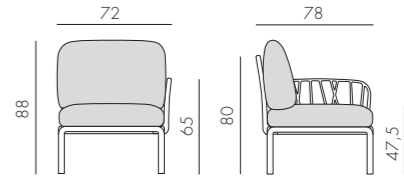

12,6 kg
n. pz. 1

KOMODO ELEMENTO CENTRALE

polipropilene fiberglass
tessuto

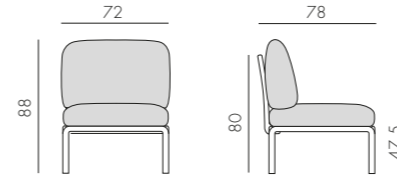

10,9 kg
n. pz. 1

KOMODO ELEMENTO ANGOLO

polipropilene fiberglass
tessuto

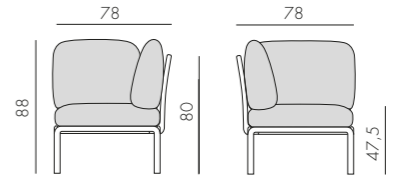

14 kg
n. pz. 1

KOMODO POUF

polipropilene fiberglass
tessuto

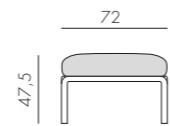

7,5 kg
n. pz. 1

KOMODO 5

polipropilene fiberglass
tessuto

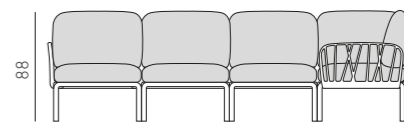
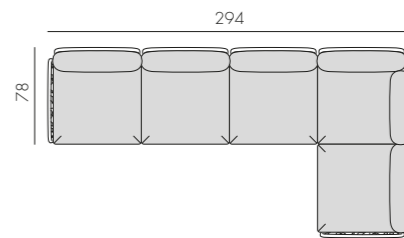

61 kg
n. pz. 1

Variazioni di colore sono da ritenersi standard e naturali nei tessuti acrilici tinto filo. Posizionare in zone d'ombra - Colour variations are to be considered standard and natural in yarn-dyed acrylic fabrics. Position in shaded areas - Les variations de couleur des tissus acryliques au fil teint sont standard et naturelles. Placer dans des zones ombragées - Farbveränderungen sind als Standard und in im Garn gefärbten Acrylgeweben als natürlich zu betrachten. In schattigen Bereichen aufstellen - Las variaciones de color son normales y naturales en las telas acrílicas teñidas en hilo. Colocar en zonas de sombra - As variações de cor são consideradas standard e naturais nos tecidos acrílico tingidos com fio. Posicionar em zonas de sombra - Boyalı akrilik iplik kumaşlarda renk değişiklikleri standart ve doğal kabul edilir. Gölgeli alanlara yerleştiriniz - Изменения цвета следует считать нормой, они являются естественными в случае акриловых тканей с окрашенными волокнами. Размещать в тени.



	POLTRONA	ELEMENTO TERMINALE DX/SX	ELEMENTO CENTRALE	ELEMENTO ANGOLO	POUF	KOMODO 5	
BIANCO rosa quarzo #		40371.00.066	40372.00.066	40373.00.066	40374.00.066	40369.00.066	40370.00.066
ANTRACITE rosa quarzo #		40371.02.066	40372.02.066	40373.02.066	40374.02.066	40369.02.066	40370.02.066
TORTORA rosa quarzo #		40371.10.066	40372.10.066	40373.10.066	40374.10.066	40369.10.066	40370.10.066
AGAVE rosa quarzo #		40371.16.066	40372.16.066	40373.16.066	40374.16.066	40369.16.066	40370.16.066
BIANCO grigio #		40371.00.163	40372.00.163	40373.00.163	40374.00.163	40369.00.163	40370.00.163
ANTRACITE grigio #		40371.02.163	40372.02.163	40373.02.163	40374.02.163	40369.02.163	40370.02.163
TORTORA grigio #		40371.10.163	40372.10.163	40373.10.163	40374.10.163	40369.10.163	40370.10.163
AGAVE grigio #		40371.16.163	40372.16.163	40373.16.163	40374.16.163	40369.16.163	40370.16.163

Variazioni di colore sono da ritenersi standard e naturali nei tessuti acrilici tinto filo. Posizionare in zone d'ombra - Colour variations are to be considered standard and natural in yarn-dyed acrylic fabrics. Position in shaded areas - Les variations de couleur des tissus acryliques au fil teint sont standard et naturelles. Placer dans des zones ombragées - Farbveränderungen sind als Standard und in im Garn gefärbten Acrylgeweben als natürlich zu betrachten. In schattigen Bereichen aufstellen - Las variaciones de color son normales y naturales en las telas acrílicas teñidas en hilo. Colocar en zonas de sombra - As variações de cor são consideradas standard e naturais nos tecidos acrílico tingidos com fio. Posicionar em zonas de sombra - Boyalı akrilik iplik kumaşlarda renk değişiklikleri standart ve doğal kabul edilir. Gölgeli alanlara yerleştiriniz - Изменения цвета следует считать нормой, они являются естественными в случае акриловых тканей с окрашенными волокнами. Размещать в тени.



	POLTRONA	ELEMENTO TERMINALE DX/SX	ELEMENTO CENTRALE	ELEMENTO ANGOLO	POUF	KOMODO 5	
BIANCO adriatic Sunbrella® *		40371.00.142	40372.00.142	40373.00.142	40374.00.142	40369.00.142	40370.00.142
ANTRACITE adriatic Sunbrella® *		40371.02.142	40372.02.142	40373.02.142	40374.02.142	40369.02.142	40370.02.142
TORTORA adriatic Sunbrella® *		40371.10.142	40372.10.142	40373.10.142	40374.10.142	40369.10.142	40370.10.142
AGAVE adriatic Sunbrella® *		40371.16.142	40372.16.142	40373.16.142	40374.16.142	40369.16.142	40370.16.142
BIANCO ghiaccio Sunbrella® *		40371.00.138	40372.00.138	40373.00.138	40374.00.138	40369.00.138	40370.00.138
ANTRACITE ghiaccio Sunbrella® *		40371.02.138	40372.02.138	40373.02.138	40374.02.138	40369.02.138	40370.02.138
TORTORA ghiaccio Sunbrella® *		40371.10.138	40372.10.138	40373.10.138	40374.10.138	40369.10.138	40370.10.138
AGAVE ghiaccio Sunbrella® *		40371.16.138	40372.16.138	40373.16.138	40374.16.138	40369.16.138	40370.16.138

* Trattamento laminato su richiesta con quantità minima. - Laminated finish available on request with a minimum quantity. - Traitement laminé sur demande avec une quantité minimum. - Laminierter Ausrüstung auf Anfrage mit einer Mindestmenge. - Tratamiento laminado bajo pedido con una cantidad mínima. - Tratamento laminado sob encomenda com quantidade mínima. - Talep üzerine minimum miktarda lamine işlem. - Ламинированная обработка по запросу с минимальным количеством.



	POLTRONA	ELEMENTO TERMINALE DX/SX	ELEMENTO CENTRALE	ELEMENTO ANGOLO	POUF	KOMODO 5
BIANCO avocado Sunbrella® *		40371.00.139	40372.00.139	40373.00.139	40374.00.139	40369.00.139 40370.00.139
ANTRACITE avocado Sunbrella® *		40371.02.139	40372.02.139	40373.02.139	40374.02.139	40369.02.139 40370.02.139
TORTORA avocado Sunbrella® *		40371.10.139	40372.10.139	40373.10.139	40374.10.139	40369.10.139 40370.10.139
AGAVE avocado Sunbrella® *		40371.16.139	40372.16.139	40373.16.139	40374.16.139	40369.16.139 40370.16.139
BIANCO giungla Sunbrella® *		40371.00.140	40372.00.140	40373.00.140	40374.00.140	40369.00.140 40370.00.140
ANTRACITE giungla Sunbrella® *		40371.02.140	40372.02.140	40373.02.140	40374.02.140	40369.02.140 40370.02.140
TORTORA giungla Sunbrella® *		40371.10.140	40372.10.140	40373.10.140	40374.10.140	40369.10.140 40370.10.140
AGAVE giungla Sunbrella® *		40371.16.140	40372.16.140	40373.16.140	40374.16.140	40369.16.140 40370.16.140

* Trattamento laminato su richiesta con quantità minima. - Laminated finish available on request with a minimum quantity. - Traitement laminé sur demande avec une quantité minimum. - Laminier-te Ausrüstung auf Anfrage mit einer Mindestmenge. - Tratamiento laminado bajo pedido con una cantidad mínima. - Tratamento laminado sob encomenda com quantidade mínima. - Talep üzerine minimum miktarda lamine işlem. - Ламинированная обработка по запросу с минимальным количеством.



	POLTRONA	ELEMENTO TERMINALE DX/SX	ELEMENTO CENTRALE	ELEMENTO ANGOLO	POUF	KOMODO 5
BIANCO canvas Sunbrella® *		40371.00.141	40372.00.141	40373.00.141	40374.00.141	40369.00.141 40370.00.141
ANTRACITE canvas Sunbrella® *		40371.02.141	40372.02.141	40373.02.141	40374.02.141	40369.02.141 40370.02.141
TORTORA canvas Sunbrella® *		40371.10.141	40372.10.141	40373.10.141	40374.10.141	40369.10.141 40370.10.141
AGAVE canvas Sunbrella® *		40371.16.141	40372.16.141	40373.16.141	40374.16.141	40369.16.141 40370.16.141
BIANCO TECH panama		40371.00.131	40372.00.131	40373.00.131	40374.00.131	40369.00.131 40370.00.131
ANTRACITE TECH panama		40371.02.131	40372.02.131	40373.02.131	40374.02.131	40369.02.131 40370.02.131
TORTORA TECH panama		40371.10.131	40372.10.131	40373.10.131	40374.10.131	40369.10.131 40370.10.131
AGAVE TECH panama		40371.16.131	40372.16.131	40373.16.131	40374.16.131	40369.16.131 40370.16.131

* Trattamento laminato su richiesta con quantità minima. - Laminated finish available on request with a minimum quantity. - Traitement laminé sur demande avec une quantité minimum. - Laminier-te Ausrüstung auf Anfrage mit einer Mindestmenge. - Tratamiento laminado bajo pedido con una cantidad mínima. - Tratamento laminado sob encomenda com quantidade mínima. - Talep üzerine minimum miktarda lamine işlem. - Ламинированная обработка по запросу с минимальным количеством.

KOMODO TAVOLINO

polipropilene fiberglass

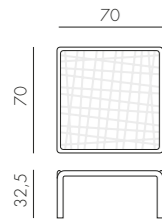

6,7 kg
n. pz. 1



BIANCO 40378.00.000 ANTRACITE 40378.02.000 TORTORA 40378.10.000 AGAVE 40378.16.000

KOMODO TAVOLINO VETRO

polipropilene fiberglass
vetro

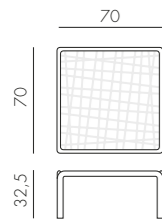

11,4 kg
n. pz. 1



BIANCO vetro 40368.00.501 ANTRACITE vetro 40368.02.501 TORTORA vetro 40368.10.501 AGAVE vetro 40368.16.501

KOMODO BRACCIOLO

polipropilene fiberglass

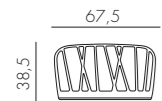

1,7 kg
n. pz. 2



BIANCO 40375.00.000 ANTRACITE 40375.02.000 TORTORA 40375.10.000 AGAVE 40375.16.000

KOMODO SCHIENALE

polipropilene fiberglass

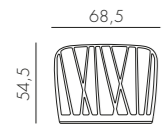

2 kg
n. pz. 4



BIANCO 40376.00.000 ANTRACITE 40376.02.000 TORTORA 40376.10.000 AGAVE 40376.16.000

CUSCINO SCHIENALE KOMODO

tessuto

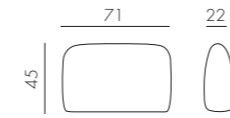

1,4 kg
n. pz. 1



rosa quarzo # 36370.52.066 grigio # 36370.52.163 adriatic Sunbrella®* 36370.52.142 ghiaccio Sunbrella®* 36370.52.138 avocado Sunbrella®* 36370.52.139



giungla Sunbrella®* 36370.52.140 canvas Sunbrella®* 36370.52.141 TECH panama 36370.52.131

CUSCINO SCHIENALE ANGOLO KOMODO

tessuto

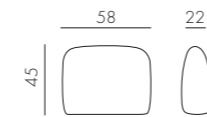

1,1 kg
n. pz. 1



rosa quarzo # 36370.54.066 grigio # 36370.54.163 adriatic Sunbrella®* 36370.54.142 ghiaccio Sunbrella®* 36370.54.138 avocado Sunbrella®* 36370.54.139



giungla Sunbrella®* 36370.54.140 canvas Sunbrella®* 36370.54.141 TECH panama 36370.54.131

Variazioni di colore sono da ritenersi standard e naturali nei tessuti acrilici tinto filo. Posizionare in zone d'ombra - Colour variations are to be considered standard and natural in yarn-dyed acrylic fabrics. Position in shaded areas - Les variations de couleur des tissus acryliques au fil teint sont standard et naturelles. Placer dans des zones ombragées - Farbveränderungen sind als Standard und in im Garn gefärbten Acrylgeweben als natürlich zu betrachten. In schattigen Bereichen aufstellen - Las variaciones de color son normales y naturales en las telas acrílicas teñidas en hilo. Colocar en zonas de sombra - As variações de cor são consideradas standard e naturais nos tecidos acrílico tingidos com fio. Posicionar em zonas de sombra - Boyalı akrilik iplik kumaşlarda renk değişiklikleri standart ve doğal kabul edilir. Gölgeli alanlara yerleştiriniz - Изменения цвета следует считать нормой, они являются естественными в случае акриловых тканей с окрашенными волокнами. Размещать в тени.

* Trattamento laminato su richiesta con quantità minima. - Laminated finish available on request with a minimum quantity. - Traitement laminé sur demande avec une quantité minimum. - Laminierter Ausrüstung auf Anfrage mit einer Mindestmenge. - Tratamiento laminado bajo pedido con una cantidad mínima. - Tratamento laminado sob encomenda com quantidade mínima. - Talep üzerine minimum miktarda lamine işlem. - Ламинированная обработка по запросу с минимальным количеством.

TRILL ARMCHAIR

polipropilene fiberglass

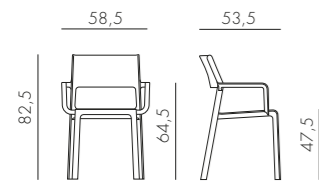

4,7 kg
n. pz. 6



BIANCO 40250.00.000 ANTRACITE 40250.02.000 GRIGIO 40250.03.000 ROSA BOUQUET 40250.08.000 TORTORA 40250.10.000 AGAVE 40250.16.000



OTTANIO 40250.49.000 TABACCO 40250.53.000 SENAPE 40250.56.000

TRILL STOOL

polipropilene fiberglass

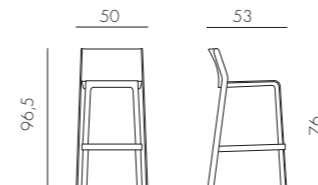

5,1 kg
n. pz. 4



BIANCO 40350.00.000 ANTRACITE 40350.02.000 GRIGIO 40350.03.000 ROSA BOUQUET 40350.08.000 TORTORA 40350.10.000 AGAVE 40350.16.000



OTTANIO 40350.49.000 TABACCO 40350.53.000 SENAPE 40350.56.000

TRILL BISTROT

polipropilene fiberglass

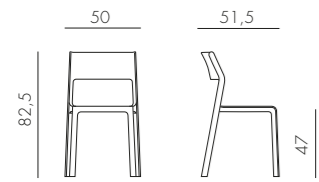

4,2 kg
n. pz. 6



BIANCO 40253.00.000 ANTRACITE 40253.02.000 GRIGIO 40253.03.000 ROSA BOUQUET 40253.08.000 TORTORA 40253.10.000 AGAVE 40253.16.000



OTTANIO 40253.49.000 TABACCO 40253.53.000 SENAPE 40253.56.000

TRILL STOOL MINI

polipropilene fiberglass

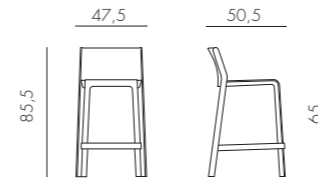

4,8 kg
n. pz. 4



BIANCO 40353.00.000 ANTRACITE 40353.02.000 GRIGIO 40353.03.000 ROSA BOUQUET 40353.08.000 TORTORA 40353.10.000 AGAVE 40353.16.000



OTTANIO 40353.49.000 TABACCO 40353.53.000 SENAPE 40353.56.000

NET BENCH

polipropilene fiberglass

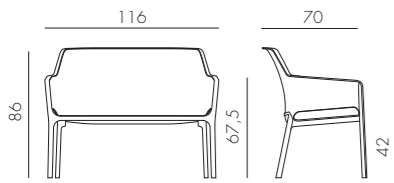

8,9 kg
n. pz. 20



BIANCO 40338.00.000 ANTRACITE 40338.02.000 SALICE 40338.04.000 TORTORA 40338.10.000 SENAPE 40338.56.000 CORALLO 40338.75.000

NET STOOL

polipropilene fiberglass

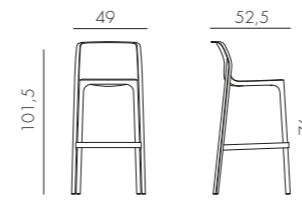

4,4 kg
n. pz. 4



BIANCO 40355.00.000 ANTRACITE 40355.02.000 SALICE 40355.04.000 TORTORA 40355.10.000 SENAPE 40355.56.000 CORALLO 40355.75.000

NET RELAX

polipropilene fiberglass

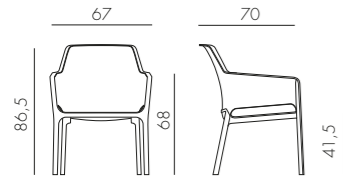

4,9 kg
n. pz. 20



pz. 6



BIANCO 40327.00.000 ANTRACITE 40327.02.000 SALICE 40327.04.000 TORTORA 40327.10.000 SENAPE 40327.56.000 CORALLO 40327.75.000

NET STOOL MINI

polipropilene fiberglass

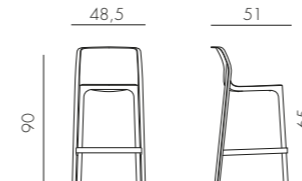

4,2 kg
n. pz. 4



BIANCO 40356.00.000 ANTRACITE 40356.02.000 SALICE 40356.04.000 TORTORA 40356.10.000 SENAPE 40356.56.000 CORALLO 40356.75.000

NET

polipropilene fiberglass

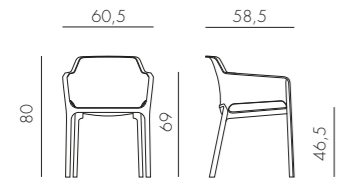

3,9 kg
n. pz. 6



pz. 6



BIANCO 40326.00.000.06 ANTRACITE 40326.02.000.06 SALICE 40326.04.000.06 TORTORA 40326.10.000.06 SENAPE 40326.56.000.06 CORALLO 40326.75.000.06

BIT

polipropilene fiberglass

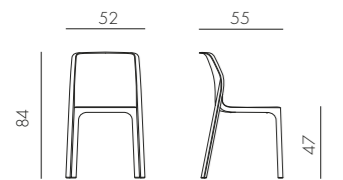

3,5 kg
n. pz. 6



BIANCO 40328.00.000.06 ANTRACITE 40328.02.000.06 SALICE 40328.04.000.06 TORTORA 40328.10.000.06 SENAPE 40328.56.000.06 CORALLO 40328.75.000.06

BORA

polipropilene fiberglass

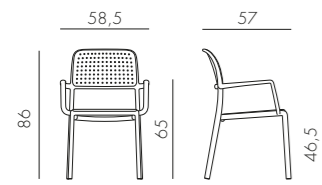

4,4 kg
n. pz. 6



BIANCO 40242.00.000.06 ANTRACITE 40242.02.000.06 CAFFÈ 40242.05.000.06 ROSSO 40242.07.000.06 TORTORA 40242.10.000.06 AGAVE 40242.16.000.06 CELESTE 40242.39.000.06

COSTA

polipropilene fiberglass

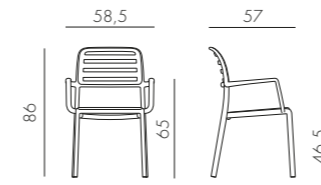

4,5 kg
n. pz. 6



BIANCO 40244.00.000.06 ANTRACITE 40244.02.000.06 CAFFÈ 40244.05.000.06 ROSSO 40244.07.000.06 TORTORA 40244.10.000.06 AGAVE 40244.16.000.06 CELESTE 40244.39.000.06

BORA BISTROT

polipropilene fiberglass

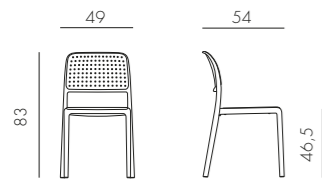

3,7 kg
n. pz. 6



BIANCO 40243.00.000.06 ANTRACITE 40243.02.000.06 CAFFÈ 40243.05.000.06 ROSSO 40243.07.000.06 TORTORA 40243.10.000.06 AGAVE 40243.16.000.06 CELESTE 40243.39.000.06

COSTA BISTROT

polipropilene fiberglass

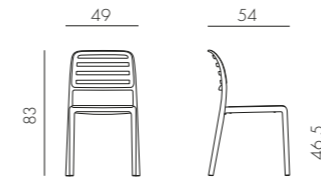

3,9 kg
n. pz. 6



BIANCO 40245.00.000.06 ANTRACITE 40245.02.000.06 CAFFÈ 40245.05.000.06 ROSSO 40245.07.000.06 TORTORA 40245.10.000.06 AGAVE 40245.16.000.06 CELESTE 40245.39.000.06

RIVA

polipropilene fiberglass

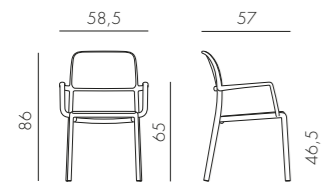

4,6 kg
n. pz. 6



BIANCO 40246.00.000.06 ANTRACITE 40246.02.000.06 CAFFÈ 40246.05.000.06 ROSSO 40246.07.000.06 TORTORA 40246.10.000.06 AGAVE 40246.16.000.06 CELESTE 40246.39.000.06

LIDO

polipropilene fiberglass

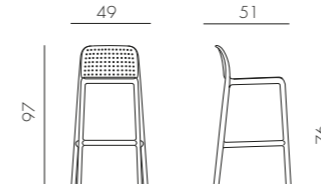

4,3 kg
n. pz. 4



BIANCO 40344.00.000 ANTRACITE 40344.02.000 CAFFÈ 40344.05.000 ROSSO 40344.07.000 TORTORA 40344.10.000 AGAVE 40344.16.000 CELESTE 40344.39.000

RIVA BISTROT

polipropilene fiberglass

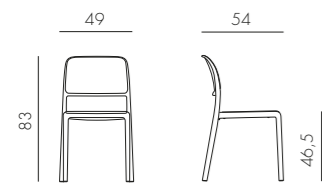

4 kg
n. pz. 6



BIANCO 40247.00.000.06 ANTRACITE 40247.02.000.06 CAFFÈ 40247.05.000.06 ROSSO 40247.07.000.06 TORTORA 40247.10.000.06 AGAVE 40247.16.000.06 CELESTE 40247.39.000.06

LIDO MINI

polipropilene fiberglass

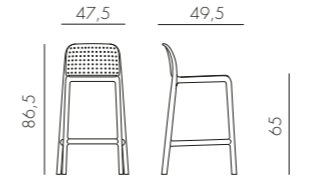

3,9 kg
n. pz. 4



BIANCO 40345.00.000 ANTRACITE 40345.02.000 CAFFÈ 40345.05.000 ROSSO 40345.07.000 TORTORA 40345.10.000 AGAVE 40345.16.000 CELESTE 40345.39.000

FARO

polipropilene fiberglass

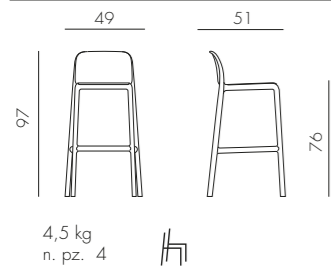

PALMA

polipropilene

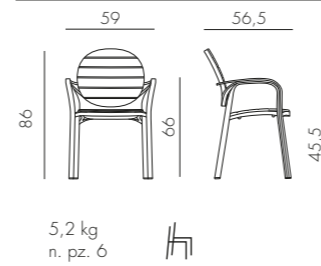

FARO MINI

polipropilene fiberglass

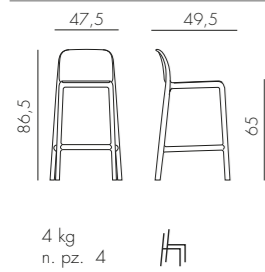

ERICA

polipropilene

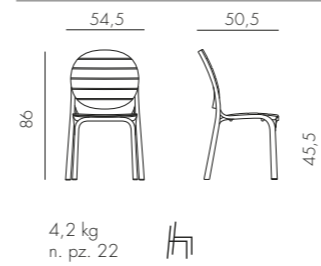

ACQUAMARINA

polipropilene fiberglass

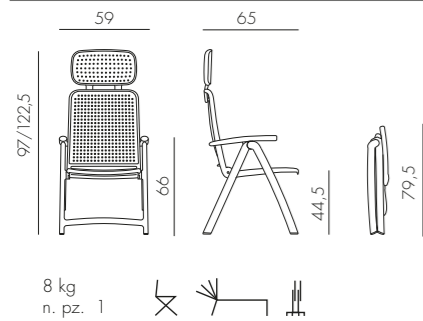

GARDENIA

polipropilene

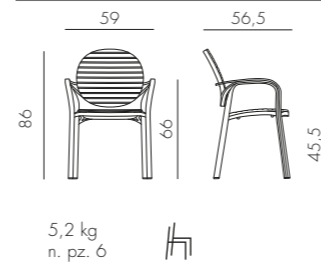

DARSENA

polipropilene fiberglass

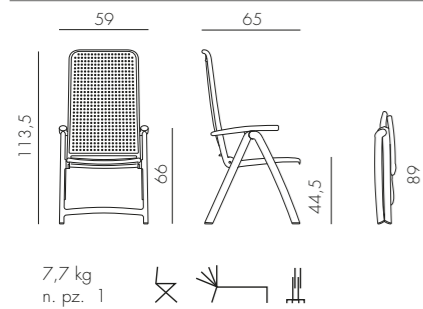

DALIA

polipropilene

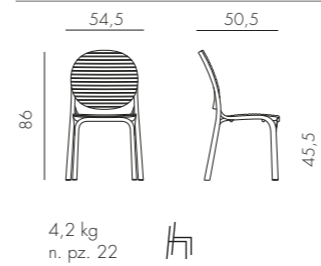

ARIA (POLTRONA ARIA + CUSCINO SEDUTA + CUSCINO ARREDO)

polipropilene
tessuto

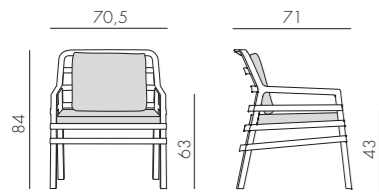

7,9 kg
n. pz. 1

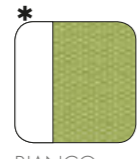

BIANCO
lime #
40330.00.061.061



BIANCO
cherry #
40330.00.065.065

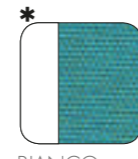

BIANCO
sardinia #
40330.00.072.072

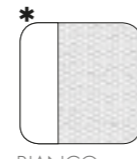

BIANCO
bianco
40330.00.155.155



BIANCO
caffè
40330.00.165.165

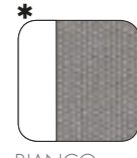

BIANCO
grigio #
40330.00.163.163

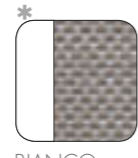

BIANCO
grigio Sunbrella@
40330.00.136.136

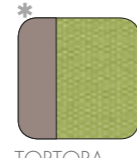

TORTORA
lime #
40330.10.061.061

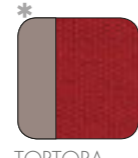

TORTORA
cherry #
40330.10.065.065

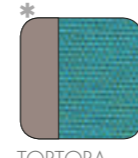

TORTORA
sardinia #
40330.10.072.072

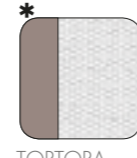

TORTORA
bianco
40330.10.155.155



TORTORA
caffè
40330.10.165.165

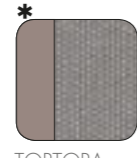

TORTORA
grigio #
40330.10.163.163

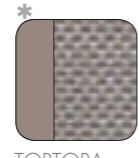

TORTORA
grigio Sunbrella@
40330.10.136.136

* Disponibile a magazzino
Available ex-stock
Disponibile sur stock
Ab lager verfügbar
Disponibile en almacén
habitualmente
Disponível em estoque
Stokta mevcut
Наличие на складе

* Disponibile su ordine
Available to order
Disponibile sur commande
Mit Auftrag verfügbar
Disponibile sólo sobre pedido
Disponível sob encomenda
Sipariş göre hazırlanacaktır
Под заказ

Variazioni di colore sono da ritenersi standard e naturali nei tessuti acrilici tinto filo. Posizionare in zone d'ombra - Colour variations are to be considered standard and natural in yarn-dyed acrylic fabrics. Position in shaded areas - Les variations de couleur des tissus acryliques au fil teint sont standard et naturelles. Placer dans des zones ombragées - Farbveränderungen sind als Standard und in im Garn gefärbten Acrylgeweben als natürlich zu betrachten. In schattigen Bereichen aufstellen - Las variaciones de color son normales y naturales en las telas acrílicas teñidas en hilo. Colocar en zonas de sombra - As variações de cor são consideradas standard e naturais nos tecidos acrílico tingidos com fio. Posicionar em zonas de sombra - Boyalı akrilik iplik kumaşlarda renk değişiklikleri standart ve doğal kabul edilir. Gölge alanlara yerleştiriniz - Изменения цвета следует считать нормой, они являются естественными в случае акриловых тканей с окрашенными волокнами. Размещать в тени.

ARIA FIT (POLTRONA ARIA + CUSCINO SEDUTA + CUSCINO FIT)

polipropilene
tessuto

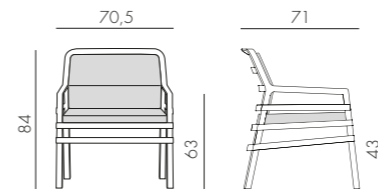

7,9 kg
n. pz. 1

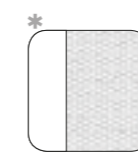

BIANCO
bianco
40330.00.155.FIT



BIANCO
caffè
40330.00.165.FIT

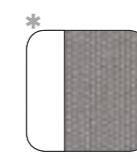

BIANCO
grigio #
40330.00.163.FIT

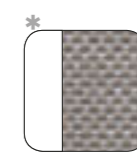

BIANCO
grigio Sunbrella@
40330.00.136.FIT

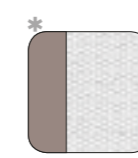

TORTORA
bianco
40330.10.155.FIT



TORTORA
caffè
40330.10.165.FIT

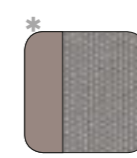

TORTORA
grigio #
40330.10.163.FIT

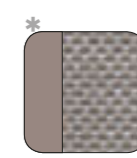

TORTORA
grigio Sunbrella@
40330.10.136.FIT

* Disponibile su ordine
Available to order
Disponibile sur commande
Mit Auftrag verfügbar
Disponibile sólo sobre pedido
Disponível sob encomenda
Sipariş göre hazırlanacaktır
Под заказ

Variazioni di colore sono da ritenersi standard e naturali nei tessuti acrilici tinto filo. Posizionare in zone d'ombra - Colour variations are to be considered standard and natural in yarn-dyed acrylic fabrics. Position in shaded areas - Les variations de couleur des tissus acryliques au fil teint sont standard et naturelles. Placer dans des zones ombragées - Farbveränderungen sind als Standard und in im Garn gefärbten Acrylgeweben als natürlich zu betrachten. In schattigen Bereichen aufstellen - Las variaciones de color son normales y naturales en las telas acrílicas teñidas en hilo. Colocar en zonas de sombra - As variações de cor são consideradas standard e naturais nos tecidos acrílico tingidos com fio. Posicionar em zonas de sombra - Boyalı akrilik iplik kumaşlarda renk değişiklikleri standart ve doğal kabul edilir. Gölge alanlara yerleştiriniz - Изменения цвета следует считать нормой, они являются естественными в случае акриловых тканей с окрашенными волокнами. Размещать в тени.

NINFEA DINNER

polipropilene
alluminio

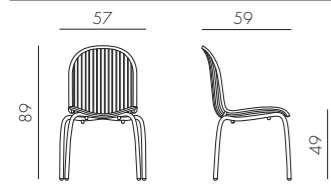

4,5 kg
n. pz. 6



ANTRACITE
verniciato antracite
62052.02.000

BIANCO
verniciato bianco
62053.00.000

NINFEA RELAX

polipropilene
alluminio

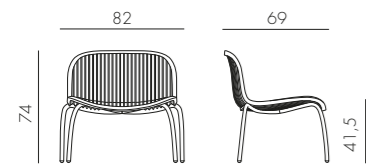

7,2 kg
n. pz. 2



ANTRACITE
verniciato antracite
62252.02.000

BIANCO
verniciato bianco
62253.00.000

MUSA

polipropilene
alluminio

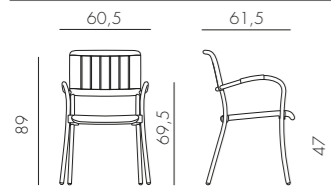

4,2 kg
n. pz. 24



ANTRACITE
verniciato antracite
61052.02.000

TORTORA
verniciato tortora
61059.10.000

DAMA

polipropilene fiberglass
alluminio

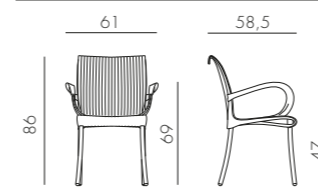

4,1 kg
n. pz. 18



ANTRACITE
verniciato antracite
61652.02.000

BURRO
verniciato burro
61658.28.000

TORTORA
verniciato tortora
61659.10.000

REGINA

polipropilene fiberglass
alluminio

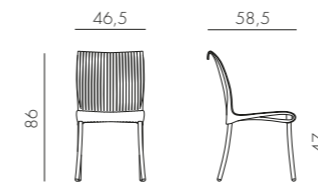

3,3 kg
n. pz. 18



ANTRACITE
verniciato antracite
61852.02.000

BURRO
verniciato burro
61858.28.000

TORTORA
verniciato tortora
61859.10.000

DUCA

polipropilene fiberglass
alluminio

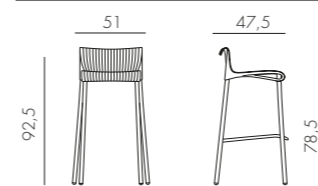

3,9 kg
n. pz. 4



ANTRACITE
verniciato antracite
75252.02.000

BURRO
verniciato burro
75258.28.000

TORTORA
verniciato tortora
75259.10.000

ATLANTICO

polipropilene fiberglass
tessuto sintetico

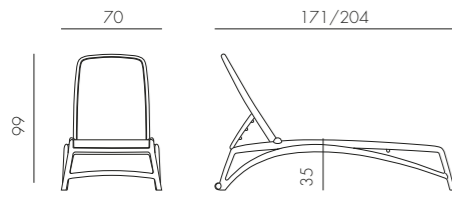

16 kg
n. pz. 20

Tessuto ricambiabile
Replaceable fabric
Tissu changeable
Auswechselbarer Stoff
Tela sustituibile
Tecidos recambiáveis
Değiştirilebilen Kumaş
Съемная ткань

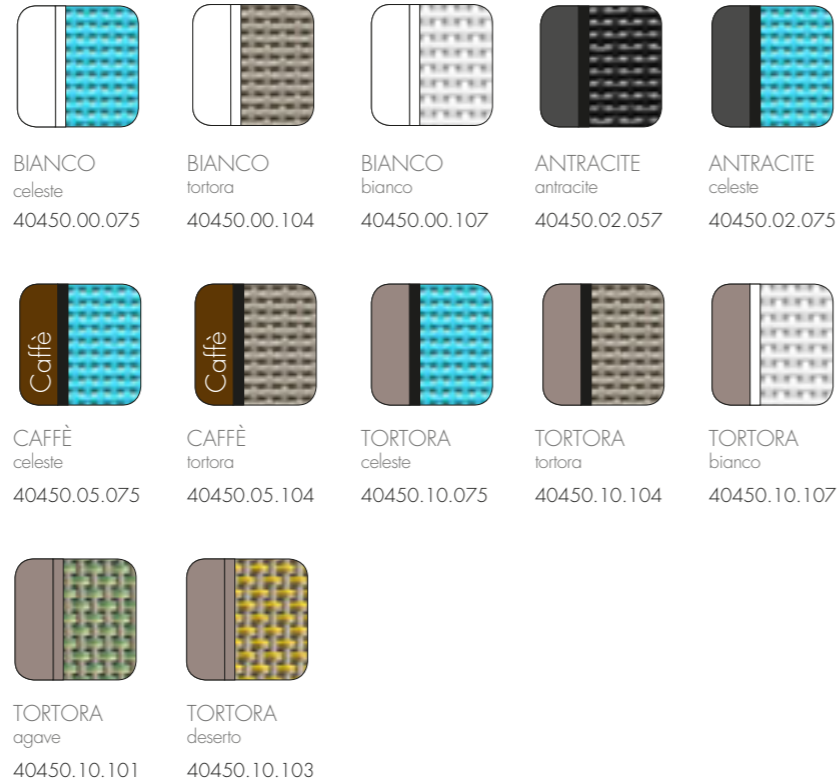

BRACCIOLO ATLANTICO

polipropilene fiberglass

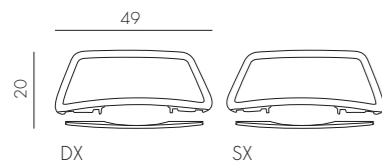

1,1 kg
n. pz. 1
1 KIT = 2 pz (1DX+1SX)

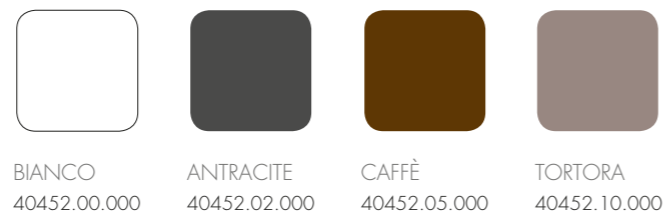

RICAMBIO atlantico

resina acetlica
tessuto sintetico

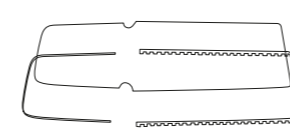

1,3 kg
n. pz. 1

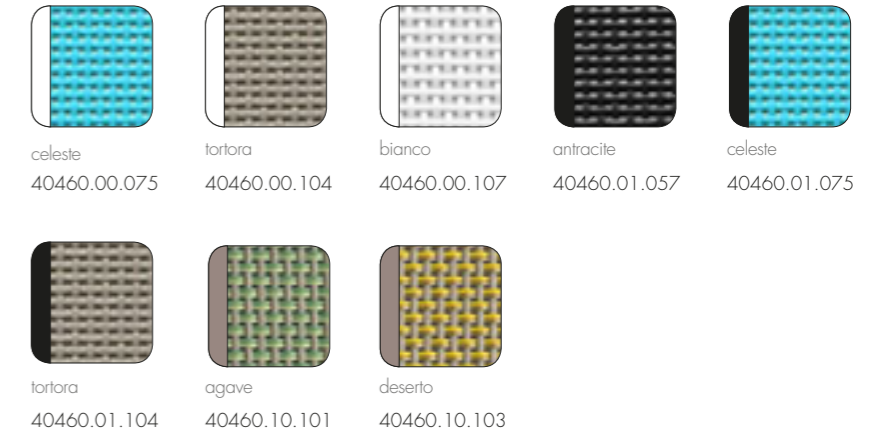

ALFA

polipropilene
tessuto sintetico

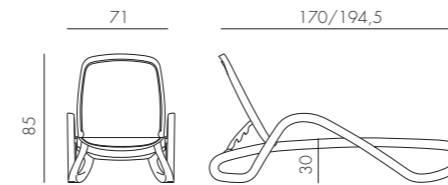

14 kg
n. pz. 17

Tessuto ricambiabile
Replaceable fabric
Tissu changeable
Auswechselbarer Stoff
Tela sustituibile
Tecidos recambiáveis
Değiştirilebilen Kumaş
Съемная ткань



OMEGA

polipropilene
tessuto sintetico

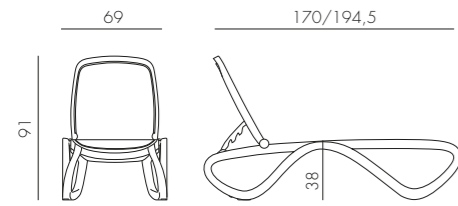

14,3 kg
n. pz. 18

Tessuto ricambiabile
Replaceable fabric
Tissu changeable
Auswechselbarer Stoff
Tela sustituible
Tecidos recambiáveis
Değiştirilebilir Kumaş
Съемная ткань

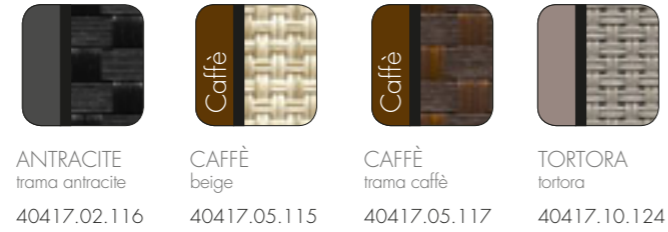

RICAMBIO ALFA - OMEGA

resina acetalica
tessuto sintetico

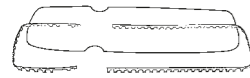

1,6 kg
n. pz. 1

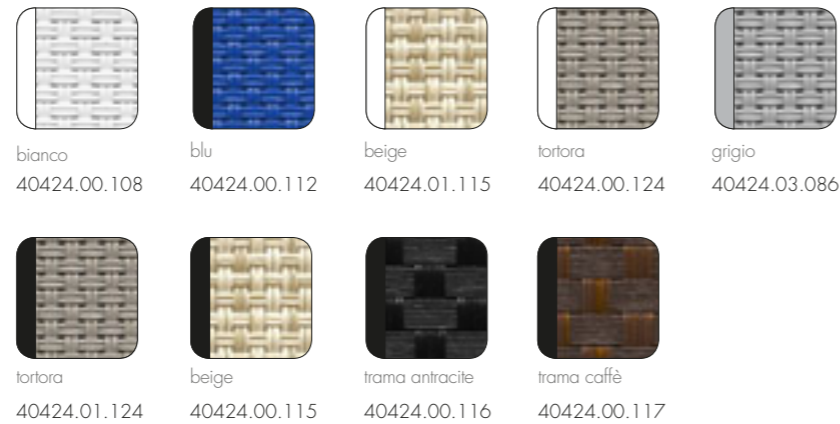

EDEN

polipropilene

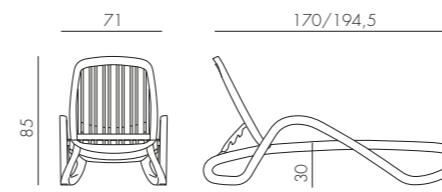

14,7 kg
n. pz. 17

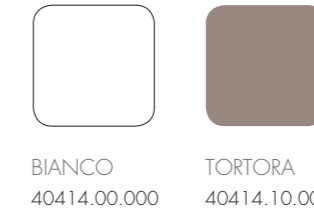

TROPICO

polipropilene

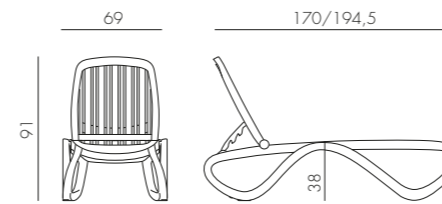

15,1 kg
n. pz. 18

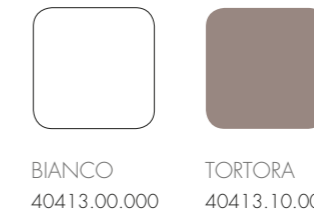

PARASOLE ALFA - OMEGA - EDEN - TROPICO

polipropilene
tessuto sintetico

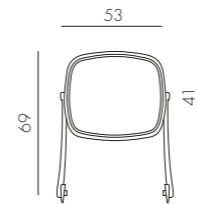

1,4 kg
n. pz. 1



CLIP 80

durelTOP
polipropilene fiberglass

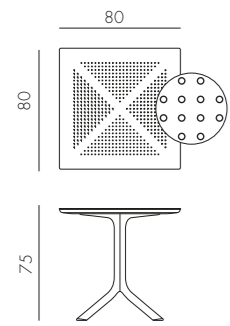

12,1 kg
n. pz. 1



BIANCO 40082.00.000
ANTRACITE 40082.02.000
TORTORA 40082.10.000
AGAVE 40082.16.000

CLIPX 70

durelTOP
polipropilene fiberglass

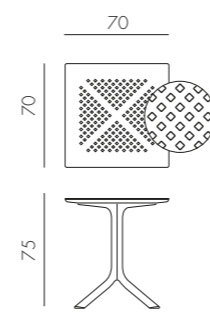

10,7 kg
n. pz. 1



BIANCO 40085.00.000
ANTRACITE 40085.02.000
TORTORA 40085.10.000

CLIP 70

durelTOP
polipropilene fiberglass

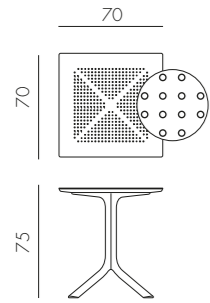

11 kg
n. pz. 1



BIANCO 40084.00.000
ANTRACITE 40084.02.000
TORTORA 40084.10.000
AGAVE 40084.16.000

BASE CLIP

TOP Ø80 - 70X70 - 80X80

polipropilene fiberglass

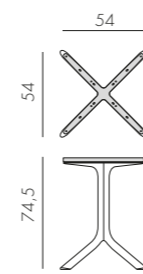

8,1 kg
n. pz. 1



BIANCO 40088.00.000
ANTRACITE 40088.02.000
TORTORA 40088.10.000
AGAVE 40088.16.000

CLIPX 80

durelTOP
polipropilene fiberglass

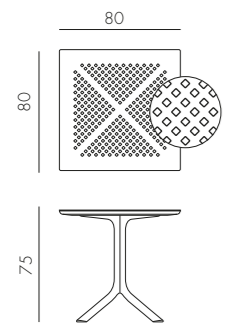

11,7 kg
n. pz. 1



BIANCO 40083.00.000
ANTRACITE 40083.02.000
TORTORA 40083.10.000

STEP

polipropilene fiberglass

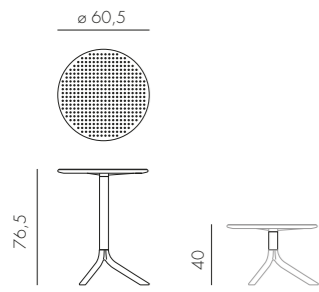

4,2 kg
n. pz. 1



SPRITZ

polipropilene fiberglass

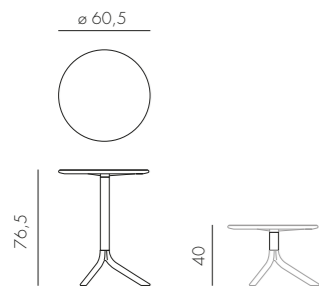

4,3 kg
n. pz. 1



NET TABLE 100

polipropilene fiberglass

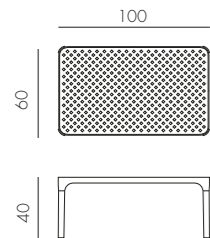

6,3 kg
n. pz. 1



ARIA TAVOLINO 100

polipropilene

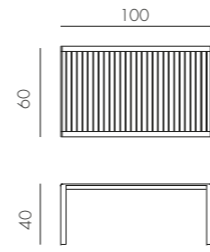

8 kg
n. pz. 1



ARIA TAVOLINO 60

polipropilene

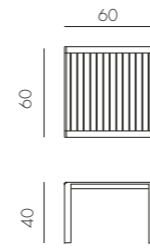

5 kg
n. pz. 1



POP

polipropilene fiberglass

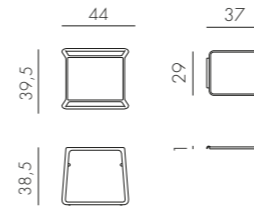

2,5 kg
n. pz. 4



CUBE 140X80

durelTOP - polipropilene
alluminio

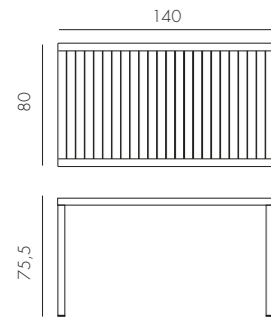

BIANCO verniciato bianco 47753.00.000	ANTRACITE * verniciato antracite 47752.02.000	CAFFÈ * verniciato caffè 47757.05.000	TORTORA verniciato tortora 47759.10.000
---	---	---	---

16,9 kg
n. pz. 1



CUBE 80

durelTOP - polipropilene
alluminio

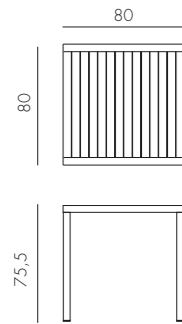

BIANCO verniciato bianco 48053.00.000	ANTRACITE verniciato antracite 48052.02.000	CAFFÈ verniciato caffè 48057.05.000	TORTORA verniciato tortora 48059.10.000
---	---	---	---

11,5 kg
n. pz. 1



CUBE 70

durelTOP - polipropilene
alluminio

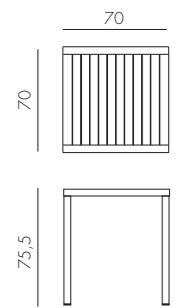

BIANCO verniciato bianco 47853.00.000	ANTRACITE verniciato antracite 47852.02.000	CAFFÈ verniciato caffè 47857.05.000	TORTORA verniciato tortora 47859.10.000
---	---	---	---

9,5 kg
n. pz. 1



KIT CUBE 140X80 HIGH

alluminio

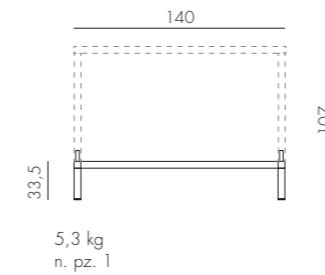

verniciato bianco 46953.00.000	verniciato antracite 46952.02.000	verniciato caffè 46957.05.000	verniciato tortora 46959.10.000
-----------------------------------	--------------------------------------	----------------------------------	------------------------------------

5,3 kg
n. pz. 1

KIT CUBE 80 HIGH

alluminio

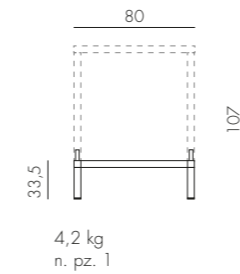

verniciato bianco 48153.00.000	verniciato antracite 48152.02.000	verniciato caffè 48157.05.000	verniciato tortora 48159.10.000
-----------------------------------	--------------------------------------	----------------------------------	------------------------------------

4,2 kg
n. pz. 1

KIT CUBE 70 HIGH

alluminio

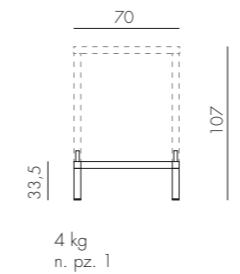

verniciato bianco 47953.00.000	verniciato antracite 47952.02.000	verniciato caffè 47957.05.000	verniciato tortora 47959.10.000
-----------------------------------	--------------------------------------	----------------------------------	------------------------------------

4 kg
n. pz. 1

* Posizionare in zona d'ombra - Only use table tops in shaded areas - Plateaux qui doivent être utilisés uniquement dans des zones ombragées - Tischplatten nur für beschatteten Einsatzbereich - Utilizar estos tableros sólo en áreas sombreadas - Colocar em local sombreado - Gölge alana koyun - Ставить в тени

MAESTRALE 90

durelTOP - polipropilene
alluminio

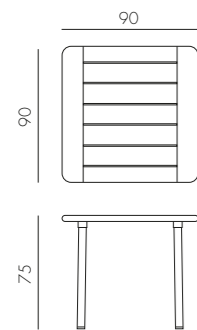

ANTRACITE *
verniciato antracite
42052.02.000

TORTORA
verniciato tortora
42059.10.000

11,7 kg
n. pz. 1



LOTO RELAX 95

vetro
alluminio

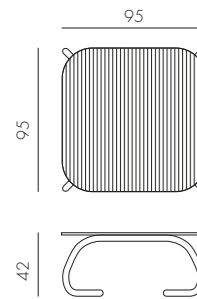

ANTRACITE
verniciato antracite
44752.02.000

BIANCO
verniciato bianco
44753.00.000

27 kg
n. pz. 1

LOTO RELAX 60

laminato
alluminio

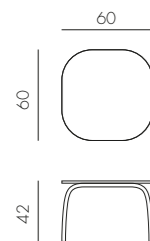

ANTRACITE *
verniciato antracite
44652.00.303

BIANCO
verniciato bianco
44653.00.301

7 kg
n. pz. 1

* Posizionare in zona d'ombra - Only use table tops in shaded areas - Plateaux qui doivent être utilisés uniquement dans des zones ombragées - Tischplatten nur für beschatteten Einsatzbereich - Utilizar estos tableros sólo en áreas sombreadas - Colocar em local sombreado - Gölge alana koyun - Ставить в тени

BASE FRASCA MAXI FIX

PIANI Ø80 - Ø90 - Ø100 ● - 80X80 - 90X90 - 100X100 ●

alluminio

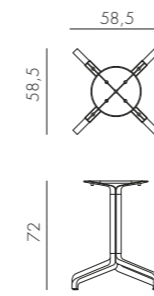

9,9 kg
n. pz. 1



verniciato antracite
53652.00.000
■ 53652.00.000.01

verniciato bianco
53653.00.000
■ 53653.00.000.01

verniciato tortora
53659.00.000
■ 53659.00.000.01

verniciato agave
53666.00.000
■ 53666.00.000.01

BASE FRASCA MINI FIX

new

PIANI Ø60 - Ø70 - Ø80 - 60X60 - 70X70 - 80X80

alluminio

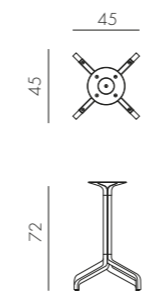

4,8 kg
n. pz. 1



verniciato antracite
53352.00.000
■ 53352.00.000.01

verniciato bianco
53353.00.000
■ 53353.00.000.01

verniciato tortora
53359.00.000
■ 53359.00.000.01

verniciato agave
53366.00.000
■ 53366.00.000.01

BASE FRASCA MINI FOLDING

PIANI Ø60 - Ø70 - Ø80 - 60X60 - 70X70 - 80X80

alluminio

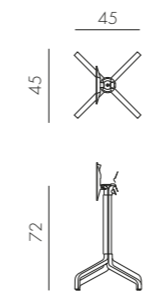

5,3 kg
n. pz. 1



verniciato antracite
53252.00.000
■ 53252.00.000.01

verniciato bianco
53253.00.000
■ 53253.00.000.01

verniciato tortora
53259.00.000
■ 53259.00.000.01

verniciato agave
53266.00.000
■ 53266.00.000.01

● solo su richiesta - only on request - uniquement sur demande - Nur auf Anfrage - sólo bajo pedido - apenas sob encomenda - sadece istek üzerine - только по запросу

■ trattamento speciale per ambienti ad alto tasso salino - special treatment for high salinity environments - traitement spécial pour les environnements a haute salinité - Sonderbehandlung für Ambiente mit hohem Salzgehalt - tratamiento especial para ambientes con alta salinidad - tratamento especial para ambientes com alto teor de sal - yüksek tuza maruz kalan alanlar için özel bakım - Специальная обработка для среды с высоким содержанием соли

Qualora il prodotto venga posizionato in ambienti altamente salini raccomandiamo di scegliere una base con trattamento speciale. If the product is placed in highly salty environments, we recommend choosing a base with a special treatment. Si le produit est placé dans des environnements a haute salinite, nous recommandons de choisir une base avec un traitement spécial. Wenn das Produkt in der Umgebung mit hohem Salzgehalt platziert ist, empfehlen wir, eine Basis mit Sonderbehandlung zu wählen. Si el producto se coloca en ambientes con alta salinidad, recomendamos elegir una base con un tratamiento especial. Se o produto for exposto em ambientes com alto teor de salinidade, recomendamos a escolha de uma base com tratamento especial. Ürünün, salinitesi yüksek olan ortamlarda kullanılması durumunda, özel muamele görmüş versiyonun seçilmesi tavsiye olunur. Если изделие будет использоваться в среде с высоким содержанием соли, рекомендуется выбирать основание со специальной обработкой.

BASE IBISCO

PIANI Ø60 - Ø70 - Ø80 - 60X60 - 70X70 - 80X80

alluminio

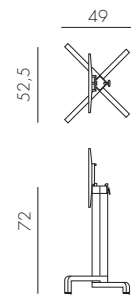

6 kg
n. pz. 1

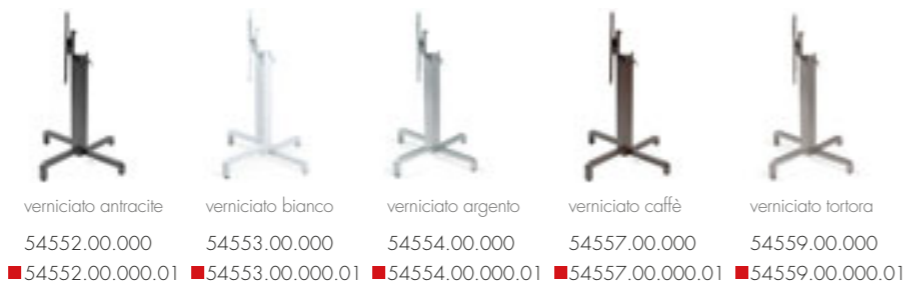

BASE FIORE HIGH

PIANI Ø60 - Ø70 - 60X60 - 70X70

alluminio

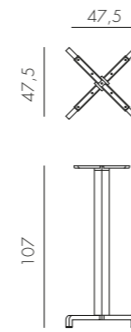

5,7 kg
n. pz. 1



BASE IBISCO HIGH

PIANI Ø60 - Ø70 - 60X60 - 70X70

alluminio

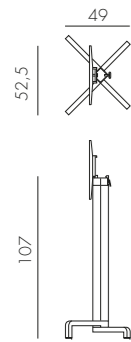

6,7 kg
n. pz. 1



BASE SCUDO

PIANI Ø60 - Ø70 - Ø80 - 60X60 - 70X70 - 80X80

alluminio

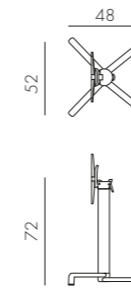

5,8 kg
n. pz. 1



BASE FIORE

PIANI Ø60 - Ø70 - Ø80 - 60X60 - 70X70 - 80X80

alluminio

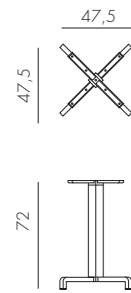

5 kg
n. pz. 1



BASE SCUDO HIGH

PIANI Ø60 - Ø70 - 60X60 - 70X70

alluminio

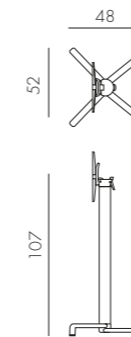

6,7 kg
n. pz. 1



■ trattamento speciale per ambienti ad alto tasso salino - special treatment for high salinity environments - traitement spécial pour les environnements a haute salinité - Sonderbehandlung für Ambiente mit hohem Salzgehalt - tratamiento especial para ambientes con alta salinidad - tratamiento especial para ambientes con alto teor de sal - yüksek tuza maruz kalan alanlar için özel bakım - Специальная обработка для среды с высоким содержанием соли

Qualora il prodotto venga posizionato in ambienti altamente salini raccomandiamo di scegliere una base con trattamento speciale. If the product is placed in highly salty environments, we recommend choosing a base with a special treatment. Si le produit est placé dans des environnements a haute salinite, nous recommandons de choisir une base avec un traitement spécial. Wenn das Produkt in der Umgebung mit hohem Salzgehalt platziert ist, empfehlen wir, eine Basis mit Sonderbehandlung zu wählen. Si el producto se coloca en ambientes con alta salinidad, recomendamos elegir una base con un tratamiento especial. Se o produto for exposto em ambientes com alto teor de salinidade, recomendamos a escolha de uma base com tratamento especial. Ürünün, salinitesi yüksek olan ortamlarda kullanılması durumunda, özel muamele görmüş versiyonun seçilmesi tavsiye olunur. Если изделие будет использоваться в среде с высоким содержанием соли, рекомендуется выбрать основание со специальной обработкой.

■ trattamento speciale per ambienti ad alto tasso salino - special treatment for high salinity environments - traitement spécial pour les environnements a haute salinité - Sonderbehandlung für Ambiente mit hohem Salzgehalt - tratamiento especial para ambientes con alta salinidad - tratamiento especial para ambientes con alto teor de sal - yüksek tuza maruz kalan alanlar için özel bakım - Специальная обработка для среды с высоким содержанием соли

Qualora il prodotto venga posizionato in ambienti altamente salini raccomandiamo di scegliere una base con trattamento speciale. If the product is placed in highly salty environments, we recommend choosing a base with a special treatment. Si le produit est placé dans des environnements a haute salinite, nous recommandons de choisir une base avec un traitement spécial. Wenn das Produkt in der Umgebung mit hohem Salzgehalt platziert ist, empfehlen wir, eine Basis mit Sonderbehandlung zu wählen. Si el producto se coloca en ambientes con alta salinidad, recomendamos elegir una base con un tratamiento especial. Se o produto for exposto em ambientes com alto teor de salinidade, recomendamos a escolha de uma base com tratamento especial. Ürünün, salinitesi yüksek olan ortamlarda kullanılması durumunda, özel muamele görmüş versiyonun seçilmesi tavsiye olunur. Если изделие будет использоваться в среде с высоким содержанием соли, рекомендуется выбрать основание со специальной обработкой.

BASE SCUDO DOUBLE

PIANI 110X170 - 120X80

alluminio

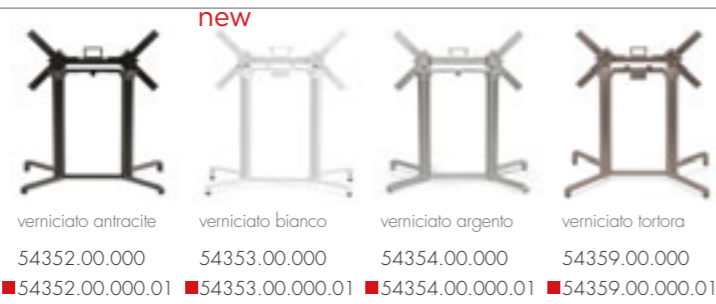
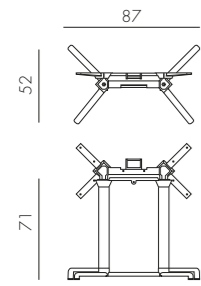

verniciato antracite	verniciato bianco	verniciato argento	verniciato tortora
54352.00.000	54353.00.000	54354.00.000	54359.00.000
■ 54352.00.000.01	■ 54353.00.000.01	■ 54354.00.000.01	■ 54359.00.000.01

8,7 kg
n. pz. 1

BASE CALICE ALU

PIANI Ø60 - Ø70 - Ø80 - 60X60 - 70X70 - 80X80

alluminio

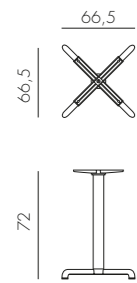

verniciato antracite	verniciato bianco	verniciato argento	verniciato tortora
52652.00.000	52653.00.000	52654.00.000	52659.00.000
■ 52652.00.000.01	■ 52653.00.000.01	■ 52654.00.000.01	■ 52659.00.000.01

4,5 kg
n. pz. 1

BASE CALICE ALU HIGH

PIANI Ø60 - Ø70 - 60X60 - 70X70

alluminio

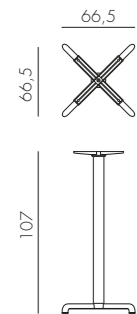

verniciato antracite	verniciato bianco	verniciato argento	verniciato tortora
52752.00.000	52753.00.000	52754.00.000	52759.00.000
■ 52752.00.000.01	■ 52753.00.000.01	■ 52754.00.000.01	■ 52759.00.000.01

5,5 kg
n. pz. 1

■ trattamento speciale per ambienti ad alto tasso salino - special treatment for high salinity environments - traitement spécial pour les environnements a haute salinité - Sonderbehandlung für Ambiente mit hohem Salzgehalt - tratamiento especial para ambientes con alta salinidad - tratamiento especial para ambientes con alto teor de sal - yüksek tuza maruz kalan alanlar için özel bakım - Специальная обработка для среды с высоким содержанием соли

Qualora il prodotto venga posizionato in ambienti altamente salini raccomandiamo di scegliere una base con trattamento speciale. If the product is placed in highly salty environments, we recommend choosing a base with a special treatment. Si le produit est placé dans des environnements a haute salinite, nous recommandons de choisir une base avec un traitement spécial. Wenn das Produkt in der Umgebung mit hohem Salzgehalt platziert ist, empfehlen wir, eine Basis mit Sonderbehandlung zu wählen. Si el producto se coloca en ambientes con alta salinidad, recomendamos elegir una base con un tratamiento especial. Se o produto for exposto em ambientes com alto teor de salinidade, recomendamos a escolha de uma base com tratamento especial. Ürünün, salinitesi yüksek olan ortamlarda kullanılması durumunda, özel muamele görmüş versiyonun seçilmesi tavsiye olunur. Если изделие будет использоваться в среде с высоким содержанием соли, рекомендуется выбрать основание со специальной обработкой.

BASE FLUTE

PIANI Ø60 - Ø70

alluminio

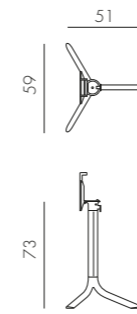

verniciato antracite	verniciato bianco	verniciato argento	verniciato tortora
55652.00.000	55653.00.000	55654.00.000	55659.00.000
■ 55652.00.000.01	■ 55653.00.000.01	■ 55654.00.000.01	■ 55659.00.000.01

4,9 kg
n. pz. 1

BASE BREAK

PIANI Ø60 - Ø70

alluminio

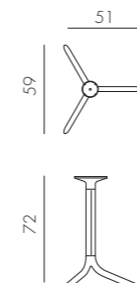

















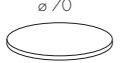

verniciato antracite	verniciato bianco	verniciato argento	verniciato tortora
55852.00.000	55853.00.000	55854.00.000	55859.00.000
■ 55852.00.000.01	■ 55853.00.000.01	■ 55854.00.000.01	■ 55859.00.000.01

4,3 kg
n. pz. 1

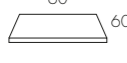
■ trattamento speciale per ambienti ad alto tasso salino - special treatment for high salinity environments - traitement spécial pour les environnements a haute salinité - Sonderbehandlung für Ambiente mit hohem Salzgehalt - tratamiento especial para ambientes con alta salinidad - tratamiento especial para ambientes con alto teor de sal - yüksek tuza maruz kalan alanlar için özel bakım - Специальная обработка для среды с высоким содержанием соли

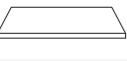









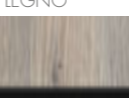

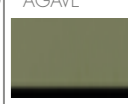

Qualora il prodotto venga posizionato in ambienti altamente salini raccomandiamo di scegliere una base con trattamento speciale. If the product is placed in highly salty environments, we recommend choosing a base with a special treatment. Si le produit est placé dans des environnements a haute salinite, nous recommandons de choisir une base avec un traitement spécial. Wenn das Produkt in der Umgebung mit hohem Salzgehalt platziert ist, empfehlen wir, eine Basis mit Sonderbehandlung zu wählen. Si el producto se coloca en ambientes con alta salinidad, recomendamos elegir una base con un tratamiento especial. Se o produto for exposto em ambientes com alto teor de salinidade, recomendamos a escolha de uma base com tratamento especial. Ürünün, salinitesi yüksek olan ortamlarda kullanılması durumunda, özel muamele görmüş versiyonun seçilmesi tavsiye olunur. Если изделие будет использоваться в среде с высоким содержанием соли, рекомендуется выбрать основание со специальной обработкой.

PIANI LAMINATO

			GRIGIO	BIANCO	CAFFÈ*	ANTRACITE*	CEMENTO	TORTORA	
		1,2 cm							
		Ø60	4,8 kg n. pz. 1	30616.10.300	30616.10.301	30616.10.302	30616.10.303	30616.10.305	30616.10.310
		Ø70	6,6 kg n. pz. 1	30617.10.300	30617.10.301	30617.10.302	30617.10.303	30617.10.305	30617.10.310
		Ø80	8,8 kg n. pz. 1	30618.10.300	30618.10.301	30618.10.302	30618.10.303	30618.10.305	30618.10.310
		Ø90	11,1 kg n. pz. 1	30619.10.300	30619.10.301	30619.10.302	30619.10.303	30619.10.305	30619.10.310
new		Ø100		(Solo su richiesta - Only on request - Uniquement sur demande - Nur auf Anfrage - Sólo bajo pedido - Apenas sob encomenda - Sadece istek üzere - Только по запросу)					
		60x60	6,1 kg n. pz. 1	30606.10.300	30606.10.301	30606.10.302	30606.10.303	30606.10.305	30606.10.310
		70x70	8,5 kg n. pz. 1	30607.10.300	30607.10.301	30607.10.302	30607.10.303	30607.10.305	30607.10.310
		80x80	11 kg n. pz. 1	30608.10.300	30608.10.301	30608.10.302	30608.10.303	30608.10.305	30608.10.310
		90x90	13,9 kg n. pz. 1	30609.10.300	30609.10.301	30609.10.302	30609.10.303	30609.10.305	30609.10.310
new		100x100		(Solo su richiesta - Only on request - Uniquement sur demande - Nur auf Anfrage - Sólo bajo pedido - Apenas sob encomenda - Sadece istek üzere - Только по запросу)					
		110x70	13,3 kg n. pz. 2	30621.10.300	30621.10.301				
		120x80	16,4 kg n. pz. 2	30620.10.300	30620.10.301				

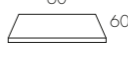
● Solo per Base Frasca Maxi Fix - Only for Base Frasca Maxi Fix - Seulement pour Base Frasca Maxi Fix - Nur für Base Frasca Maxi Fix - Sólo para Base Frasca Maxi Fix - Apenas para Base Frasca Maxi Fix - Sadece Base Frasca Maxi Fix için - Только для Base Frasca Maxi Fix

* Posizionare in zona d'ombra - Only use table tops in shaded areas - Plateaux qui doivent être utilisés uniquement dans des zones ombragées - Tischplatten nur für beschatteten Einsatzbereich - Utilizar estos tableros sólo en áreas sombreadas - Colocar em local sombreado - Gölge alana koyun - Ставить в тени

	LEGNO	CORTEN*		TOTAL WHITE	NERO FENIX NTM®	AGAVE	
							
			Ø60	4 kg n. pz. 1			30616.10.316
			Ø70	5,5 kg n. pz. 1			30617.10.316
			Ø80	7 kg n. pz. 1			30618.10.316
			Ø90	9 kg n. pz. 1			30619.10.316
new			Ø100		(Solo su richiesta - Only on request - Uniquement sur demande - Nur auf Anfrage - Sólo bajo pedido - Apenas sob encomenda - Sadece istek üzere - Только по запросу)		
			60x60	5 kg n. pz. 1	30606.10.314	30606.10.313	30606.10.316
			70x70	7 kg n. pz. 1	30607.10.314	30607.10.313	30607.10.316
			80x80	9,5 kg n. pz. 1	30608.10.314	30608.10.313	30608.10.316
			90x90	11,5 kg n. pz. 1	30609.10.314	30609.10.313	30609.10.316
new			100x100		(Solo su richiesta - Only on request - Uniquement sur demande - Nur auf Anfrage - Sólo bajo pedido - Apenas sob encomenda - Sadece istek üzere - Только по запросу)		

● Solo per Base Frasca Maxi Fix - Only for Base Frasca Maxi Fix - Seulement pour Base Frasca Maxi Fix - Nur für Base Frasca Maxi Fix - Sólo para Base Frasca Maxi Fix - Apenas para Base Frasca Maxi Fix - Sadece Base Frasca Maxi Fix için - Только для Base Frasca Maxi Fix

* Posizionare in zona d'ombra - Only use table tops in shaded areas - Plateaux qui doivent être utilisés uniquement dans des zones ombragées - Tischplatten nur für beschatteten Einsatzbereich - Utilizar estos tableros sólo en áreas sombreadas - Colocar em local sombreado - Gölge alana koyun - Ставить в тени

SIPARIO 3 **new**

polipropilene fiberglass rigenerato

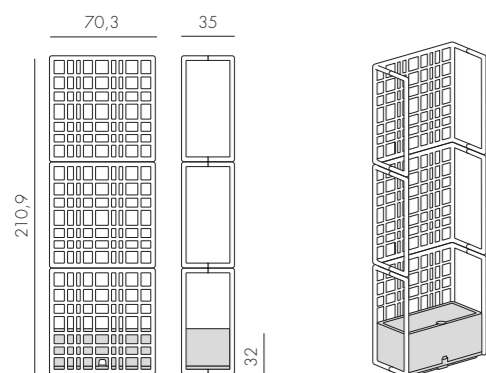

TERRA
40395.44.000

19,5 kg
n. pz. 1

SIPARIO 2 **new**

polipropilene fiberglass rigenerato

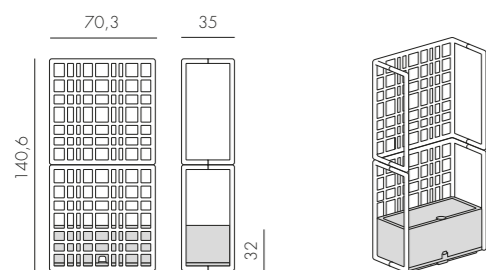

TERRA
40394.44.000

15 kg
n. pz. 1

SIPARIO MODULO **new**

polipropilene fiberglass rigenerato

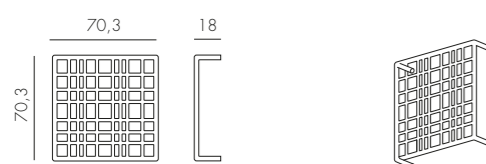

TERRA
40381.44.000

3,3 kg
n. pz. 1

SIPARIO VASO **new**

polipropilene fiberglass rigenerato

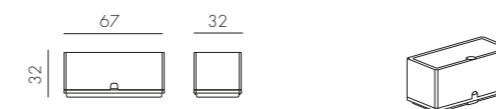

TERRA
40382.44.000

6,5 kg
n. pz. 1

SIPARIO CHIUSURA **new**

polipropilene fiberglass rigenerato

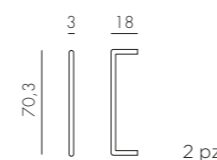

TERRA
40383.44.000

1 kg
n. pz. 1

SIPARIO KIT CLIPS **new**

polipropilene fiberglass rigenerato



TERRA
40392.44.000

0,4 kg
n. pz. 1

KOMODO ECOWALL

polipropilene fiberglass rigenerato

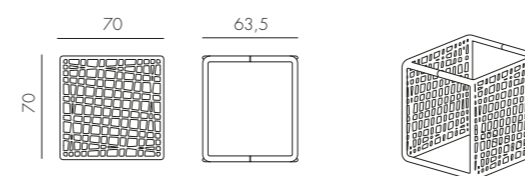

TERRA
40380.44.000

10 kg
n. pz. 1

CUSCINO NET BENCH

tessuto

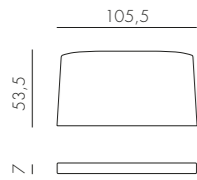

1,5 kg
n. pz. 4

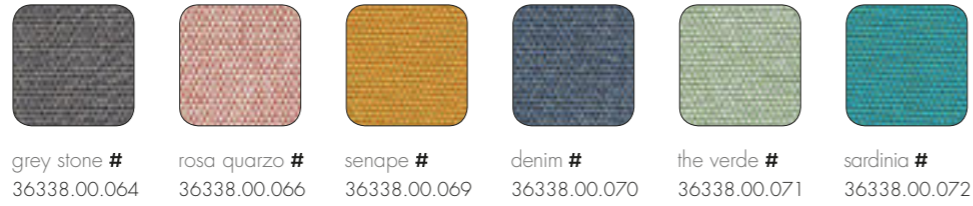

grey stone # 36338.00.064
rosa quarzo # 36338.00.066
senape # 36338.00.069
denim # 36338.00.070
the verde # 36338.00.071
sardinia # 36338.00.072



bianco 36338.00.155
grigio # 36338.00.163
grigio Sunbrella® * 36338.00.136

CUSCINO NET RELAX

tessuto

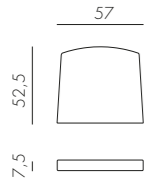

0,8 kg
n. pz. 4

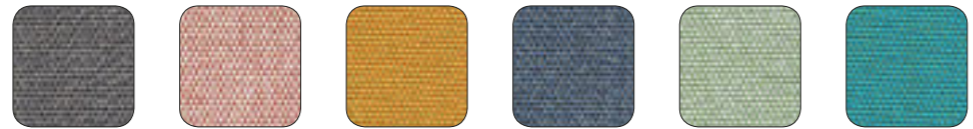

grey stone # 36327.00.064
rosa quarzo # 36327.00.066
senape # 36327.00.069
denim # 36327.00.070
the verde # 36327.00.071
sardinia # 36327.00.072



bianco 36327.00.155
grigio # 36327.00.163
grigio Sunbrella® * 36327.00.136

Variazioni di colore sono da ritenersi standard e naturali nei tessuti acrilici tinto filo. Posizionare in zone d'ombra - Colour variations are to be considered standard and natural in yarn-dyed acrylic fabrics. Position in shaded areas - Les variations de couleur des tissus acryliques au fil teint sont standard et naturelles. Placer dans des zones ombragées - Farbveränderungen sind als Standard und in im Garn gefärbten Acrylgeweben als natürlich zu betrachten. In schattigen Bereichen aufstellen - Las variaciones de color son normales y naturales en las telas acrílicas teñidas en hilo. Colocar en zonas de sombra - As variações de cor são consideradas standard e naturais nos tecidos acrílico tingidos com fio. Posicionar em zonas de sombra - Boyalı akrilik iplik kumaşlarda renk değişiklikleri standart ve doğal kabul edilir. Gölge alanlara yerleştiriniz - Изменения цвета следует считать нормой, они являются естественными в случае акриловых тканей с окрашенными волокнами. Размещать в тени.

* Trattamento laminato su richiesta con quantità minima. - Laminated finish available on request with a minimum quantity. - Traitement laminé sur demande avec une quantité minimum. - Laminierete Ausrüstung auf Anfrage mit einer Mindestmenge. - Tratamiento laminado bajo pedido con una cantidad mínima. - Tratamento laminado sob encomenda com quantidade mínima. - Talep üzerine minimum miktarda lamine işlem. - Ламинированная обработка по запросу с минимальным количеством.

CUSCINO SHELL (NET RELAX)

tessuto

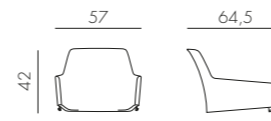

2,2 kg
n. pz. 2

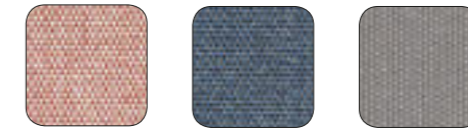

rosa quarzo # 36327.01.066
denim # 36327.01.070
grigio # 36327.01.163

Utilizzabile solo con cuscino Net Relax - Can only be used with Net Relax cushion - À utiliser uniquement avec le coussin Net Relax - Kann nur mit Net Relax Kissen verwendet werden - Se puede utilizar sólo con el cojín Net Relax - Só pode ser usada em conjunto com almofada de assento Net Relax - Sadece Net Relax minderiyle kullanılmalı - Можно использовать только с подушкой Net Relax.

CUSCINO NET

tessuto



0,3 kg
n. pz. 4

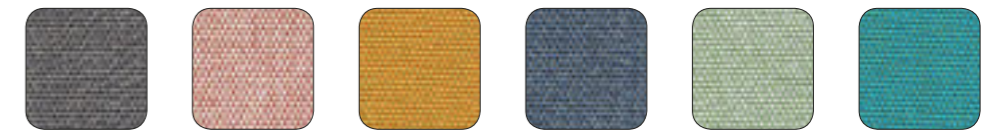

grey stone # 36326.00.064
rosa quarzo # 36326.00.066
senape # 36326.00.069
denim # 36326.00.070
the verde # 36326.00.071
sardinia # 36326.00.072



bianco 36326.00.155
grigio # 36326.00.163
grigio Sunbrella® * 36326.00.136

CUSCINO TRILL

tessuto

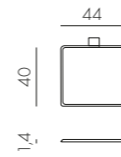

0,2 kg
n. pz. 4



cenere
36253.00.132

Solo per sedia Trill Bistrot - Only for Trill Bistrot chair - Seulement pour la chaise Trill Bistrot - Nur für Trill Bistrot Stuhl - Sólo para silla Trill Bistrot - Apenas para cadeira Trill Bistrot - Sadece Trill Bistrot sandalyesi için - Только для кресла Trill Bistrot.

Variazioni di colore sono da ritenersi standard e naturali nei tessuti acrilici tinto filo. Posizionare in zone d'ombra - Colour variations are to be considered standard and natural in yarn-dyed acrylic fabrics. Position in shaded areas - Les variations de couleur des tissus acryliques au fil teint sont standard et naturelles. Placer dans des zones ombragées - Farbveränderungen sind als Standard und in im Garn gefärbten Acrylgeweben als natürlich zu betrachten. In schattigen Bereichen aufstellen - Las variaciones de color son normales y naturales en las telas acrílicas teñidas en hilo. Colocar en zonas de sombra - As variações de cor são consideradas standard e naturais nos tecidos acrílico tingidos com fio. Posicionar em zonas de sombra - Boyalı akrilik iplik kumaşlarda renk değişiklikleri standart ve doğal kabul edilir. Gölge alanlara yerleştiriniz - Изменения цвета следует считать нормой, они являются естественными в случае акриловых тканей с окрашенными волокнами. Размещать в тени.

* Trattamento laminato su richiesta con quantità minima. - Laminated finish available on request with a minimum quantity. - Traitement laminé sur demande avec une quantité minimum. - Laminierete Ausrüstung auf Anfrage mit einer Mindestmenge. - Tratamiento laminado bajo pedido con una cantidad mínima. - Tratamento laminado sob encomenda com quantidade mínima. - Talep üzerine minimum miktarda lamine işlem. - Ламинированная обработка по запросу с минимальным количеством.

CUSCINO PASSEPARTOUT

tessuto

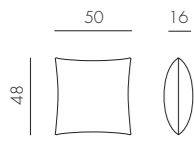

0,7 kg
n. pz. 4

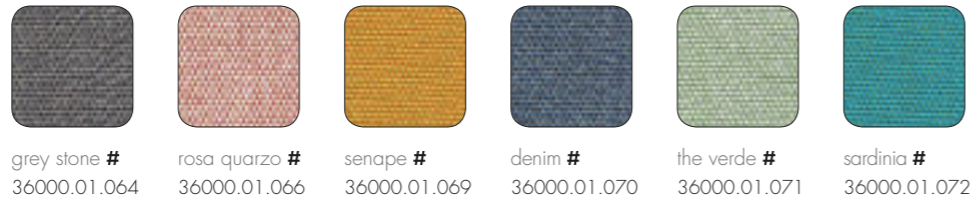

CUSCINO RETTANGOLARE

tessuto

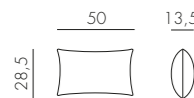

0,55 kg
n. pz. 4



CUSCINO ACQUAMARINA

tessuto

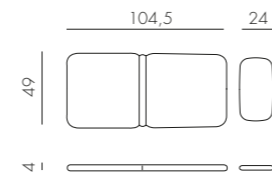

0,9 kg
n. pz. 4



CUSCINO DARSENA

tessuto

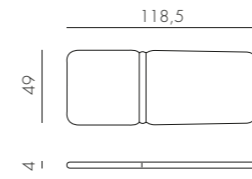

0,8 kg
n. pz. 4



CUSCINO EDEN

tessuto

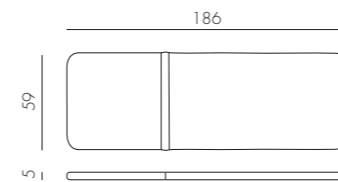

1,8 kg
n. pz. 4

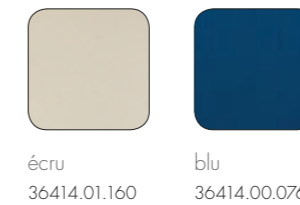

Variazioni di colore sono da ritenersi standard e naturali nei tessuti acrilici tinto filo. Posizionare in zone d'ombra - Colour variations are to be considered standard and natural in yarn-dyed acrylic fabrics. Position in shaded areas - Les variations de couleur des tissus acryliques au fil teint sont standard et naturelles. Placer dans des zones ombragées - Farbveränderungen sind als Standard und in im Garn gefärbten Acrylgeweben als natürlich zu betrachten. In schattigen Bereichen aufstellen - Las variaciones de color son normales y naturales en las telas acrílicas teñidas en hilo. Colocar en zonas de sombra - As variações de cor são consideradas standard e naturais nos tecidos acrílico tingidos com fio. Posicionar em zonas de sombra - Boyalı akrilik iplik kumaşlarda renk değişiklikleri standart ve doğal kabul edilir. Gölge alanlara yerleştiriniz - Изменения цвета следует считать нормой, они являются естественными в случае акриловых тканей с окрашенными волокнами. Размещать в тени.

Variazioni di colore sono da ritenersi standard e naturali nei tessuti acrilici tinto filo. Posizionare in zone d'ombra - Colour variations are to be considered standard and natural in yarn-dyed acrylic fabrics. Position in shaded areas - Les variations de couleur des tissus acryliques au fil teint sont standard et naturelles. Placer dans des zones ombragées - Farbveränderungen sind als Standard und in im Garn gefärbten Acrylgeweben als natürlich zu betrachten. In schattigen Bereichen aufstellen - Las variaciones de color son normales y naturales en las telas acrílicas teñidas en hilo. Colocar en zonas de sombra - As variações de cor são consideradas standard e naturais nos tecidos acrílico tingidos com fio. Posicionar em zonas de sombra - Boyalı akrilik iplik kumaşlarda renk değişiklikleri standart ve doğal kabul edilir. Gölge alanlara yerleştiriniz - Изменения цвета следует считать нормой, они являются естественными в случае акриловых тканей с окрашенными волокнами. Размещать в тени.

materiali
materials

polipropilene

Polipropilene trattato anti-UV e colorato in massa. Riciclabile al 100%.
 Polypropylene with UV additives and is uniformly colored. 100% Recyclable resin.
 Polypropylène traité anti-UV et coloré dans la masse. Résine recyclable 100%.
 UV-beständigem Polypropylen, voll durchgefärbt. 100% Recyclebarer Kunststoff.
 Polipropileno tratado anti UV y teñido en masa. Resina reciclable 100%.
 Polipropileno com tratamento anti-UV colorido na totalidade. Resina reciclável 100%.
 Işığa dayanıklı ve boyalı olarak granül çekilmiş %100 geri dönüşümlü polipropilen kompozit hammadde.
 Полипропилен с обработкой анти-УФ, окрашенное в массу. На 100% пригодно для вторичной переработки.

polipropilene fiberglass regenerato *

Polipropilene fiberglass regenerato trattato anti-UV e colorato in massa. Resina riciclabile al 100%.
 Regenerated uniformly colored fiberglass polypropylene resins with UV additives. 100% Recyclable resin.
 Polypropylène fiberglass régénérée traité anti-UV et coloré dans la masse. Résine recyclable 100%.
 UV-beständigem fiberglass Polypropylen, voll durchgefärbt. 100% Recyclebarer Kunststoff.
 Regeneriertem UV-beständigem fiberglass-Polypropylen, voll durchgefärbt. 100% Recyclebarer Kunststoff.



BIANCO .00 GRIGIO .03 ANTRACITE .02



BURRO .28 TORTORA .10 TABACCO .53 CAFFE' .05 TERRA .44 *



CELESTE .39 OTTANIO .49 SALICE .04 AGAVE .16



SENAPE .56 ROSA BOUQUET .08 CORALLO .75 ROSSO .07

polipropilene fiberglass

Polipropilene fiberglass trattato anti-UV e colorato in massa. Resina riciclabile al 100%.
 Uniformly colored fiberglass polypropylene resins with uv additives. 100% Recyclable resin.
 Polypropylène fiberglass traité anti-uv et coloré dans la masse. Résine recyclable 100%.
 UV-beständigem fiberglass Polypropylen, voll durchgefärbt. 100% Recyclebarer Kunststoff.
 Polipropileno tratado anti UV y teñido en masa. Resina reciclable 100%.
 Polipropileno fiberglass com tratamento anti-UV colorido na totalidade. Resina reciclável 100%.
 Işığa dayanıklı ve boyalı olarak granül çekilmiş %100 geri dönüşümlü cam elyaf katkılı polipropilen kompozit hammadde.
 Полипропилен фиброволокно с обработкой анти-УФ, окрашенное в массу. На 100% пригодно для вторичной переработки.

Polipropileno fiberglass regenerado tratado anti-UV y teñido en masa. Resina reciclable 100%.
 Polipropileno fiberglass regenerado com tratamento anti-UV colorido na totalidade. Resina reciclável 100%.
 Uv katlı maddeleriyle fiberglass polipropilen reçine ile renklendirilip düzgün bir şekilde tekrar oluşturulmuştur.
 Переработанный, крашеный, полипропилен fiberglass обработанный 'против проникновения ультрафиолетовых лучей. На 100% пригодно для вторичной переработки.

tessuto acrilico



Fibra acrilica 100% tinto filo. Trattamento antimacchia, antimuffa. Solidità alla luce 5/8.
 Lavabile a 30°.
 100% yarn dyed acrylic. Dirt repellent and anti-mould treatment. 5/8 light fastness.
 Washable at 30°.
 100% fibre acrylique teintée en fils. Traitement anti-taches et anti-moisissure. Résistance à la lumière 5/8. Lavable à 30°.
 100% garngefärbtes Polyacryl Gewebe. Gegen Flecken und Schimmel Ausrüstung. Lichtechtheit 5/8. Waschbar bei 30°.

100% hilo teñido acrílico. Protección antimanchas, antimoho. Solidez a la luz 5/8.
 Lavable a 30°.
 100% fibra acrílica tingida com fio. Tratamento antimancha e antimofa. Resistência à luz 5/8. Lavável a 30°.
 %100 akrilik elyaf boyalı iplik. Leke itici, küf önleyici ile muamele edilmiş. Işık haslığı 5/8. 30°de yıkanabilir.
 Акриловое волокно 100% окрашенное в пряже. Пятноустойчивая и противогрибковая обработка. Светостойкость 5/8. Стирать при 30°.

Variazioni di colore sono da ritenersi standard e naturali nei tessuti acrilici tinto filo. Posizionare in zone d'ombra - Colour variations are to be considered standard and natural in yarn-dyed acrylic fabrics. Position in shaded areas - Les variations de couleur des tissus acryliques au fil teint sont standard et naturelles. Placer dans des zones ombragées - Farbveränderungen sind als Standard und in im Garn gefärbten Acrylgeweben als natürlich zu betrachten. In schattigen Bereichen aufstellen - Las variaciones de color

son normales y naturales en las telas acrílicas teñidas en hilo. Colocar en zonas de sombra - As variações de cor são consideradas standard e naturais nos tecidos acrílico tingidos com fio. Posicionar em zonas de sombra - Boyalı akrilik iplik kumaşlarda renk değişiklikleri standart ve doğal kabul edilir. Gölge alanlara yerleştiriniz - Изменения цвета следует считать нормой, они являются естественными в случае акриловых тканей с окрашенными волокнами. Размещать в тени.



grigio .163
240 gr/m²



grey stone .064
240 gr/m²

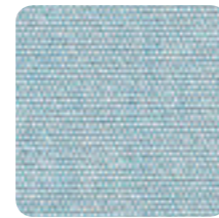

artic .161
240 gr/m²



sardinia .072
240 gr/m²

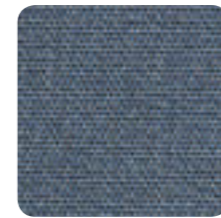

denim .070
240 gr/m²

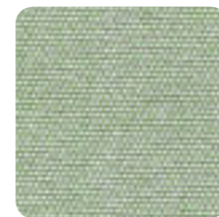

the verde .071
240 gr/m²



lime .061
240 gr/m²

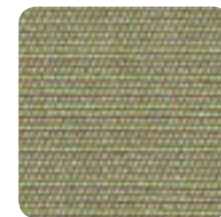

felce .162
240 gr/m²

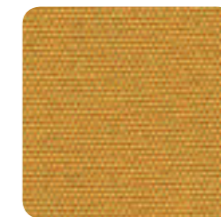

senape .069
240 gr/m²

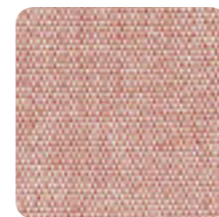

rosa quarzo .066
240 gr/m²



cherry .065
240 gr/m²

tessuto acrilico Sunbrella®



100% fibra acrilica Sunbrella® tinto in massa. Trattamento idrorepellente, antimacchia, antimuffa. Solidità alla luce 8/8. Lavabile a 40°.
100% Sunbrella® acrylic fiber mass dyed. Water repellent treatment, dirt repellent and anti-mould treatment. 8/8 light fastness. Washable at 40°.
100% fibre acrylique Sunbrella® teintée en masse. Traitement imperméable, anti-taches et anti-moisissure. Résistance à la lumière 8/8. Lavable à 40°.
100% fasergefärbtes Sunbrella® Polyacryl. Wasserabweisend Ausrüstung, gegen Flecken und Schimmel ausgerüstet. Lichtechtheit 8/8. Waschbar bei 40°.

★ 50% fibra acrilica Sunbrella® riciclata tinto in massa, 47% fibra acrilica Sunbrella® tinto in massa, 3% poliéster.
50% blended Sunbrella® acrylic fiber mass dyed, 47% Sunbrella® acrylic fiber mass dyed, 3% polyester.
50% fibre acrylique Sunbrella® recyclée teintée en masse, 47% fibre acrylique Sunbrella® teintée en masse, 3% de polyester.
50% fasergefärbtes Sunbrella® Polyacryl, 47% fasergefärbtes Sunbrella® Polyacryl, 3% Polyester.

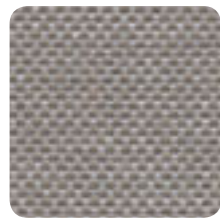

grigio
Sunbrella® .136
275 gr/m²



canvas
Sunbrella® .141
275 gr/m²



ghiaccio
Sunbrella® .138
275 gr/m²

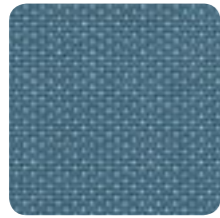

adriatic
Sunbrella® .142
260 gr/m²

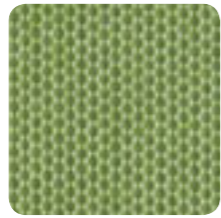

avocado
Sunbrella® .139
260 gr/m²



giungla
Sunbrella® .140 ★
340 gr/m²

tessuto acrilico tinto massa



100% fibra acrilica tinto in massa. Trattamento idrorepellente, antimacchia, antimuffa. Solidità alla luce 7/8. Lavabile a 30°.
100% acrylic fiber mass dyed. Water repellent treatment, dirt repellent and anti-mould treatment. 7/8 light fastness. Washable at 30°.
100% fibre acrylique teintée en masse. Traitement imperméable, anti-taches et anti-moisissure. Résistance à la lumière 7/8. Lavable à 30°.
100% fasergefärbtes Polyacryl. Wasserabweisend Ausrüstung, gegen Flecken und Schimmel ausgerüstet. Lichtechtheit 7/8. Waschbar bei 30°.

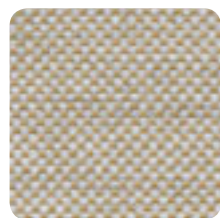

lino .152
280 gr/m²

100% fibra acrilica Sunbrella® tintada en masa. Tratamiento por la repelencia al agua, proteccion antimanchas, antimoho. Solidez a la luz 8/8. Lavable a 40°.
100% fibra acrilica Sunbrella® tingida em massa. Tratamento hidrorrepelente, antimancha e antimoho. Resistência à luz 8/8. Lavável a 40°.
%100 akrilik elyaf Sunbrella® çözelti halindeyken boyanmış. Su itici, leke itici, küf önleyici ile muamele edilmiş. Işık hızlığı 8/8. 40°de yıkanabilir.
100% акриловое волокно Sunbrella®, окрашенное в массе. Водоотталкивающая, пятноустойчивая и противогрибковая обработка. Светостойкость 8/8. Стирать при 40°.

50% fibra acrilica Sunbrella® riciclata tintada en masa, 47% fibra acrilica Sunbrella® tintada en masa, 3% poliéster.
50% fibra acrilica Sunbrella® reciclada tingida em massa, 47% fibra acrilica Sunbrella® tingida em massa, 3% de poliéster.
%50 geri dönüştürülmüş akrilik elyaf Sunbrella® çözelti halindeyken boyanmış, %47 akrilik elyaf Sunbrella® çözelti halindeyken boyanmış, % 3 polyester.
50% переработанное акриловое волокно Sunbrella® окрашенное в массе, 47% акриловое волокно Sunbrella®, окрашенное в массе, 3% полиэстер.



tropical .081
190 gr/m²



TECH panama .131
830 gr/m²

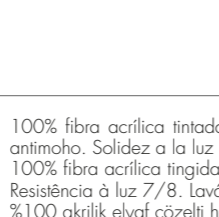

TECH panama .131
830 gr/m²



TECH panama .131
830 gr/m²

trattamento laminato

(Su richiesta - On request - Sur demande - Auf Anfrage - Bajo pedido - Sob encomenda - İstek üzerine - По запросу)



Il tessuto è accoppiato internamente con un film in poliuretano che lo rende impermeabile. La parte accoppiata in poliuretano non deve essere esposta al sole. Applicabile su richiesta con quantità minima su tessuti acrilici Sunbrella®.
The fabric is bonded with a polyurethane film that makes it waterproof. The polyurethane laminated surface should not be exposed to direct sunlight. Applicable on Sunbrella® acrylic fabrics on request with a minimum quantity.
Le tissu est doublé en interne avec un film de polyuréthane qui le rend imperméable. La partie en polyuréthane ne doit pas être exposée au soleil. Applicable sur demande avec une quantité minimale sur les tissus acryliques Sunbrella®.
Das Gewebe ist innen mit einer Polyurethanfolie verbunden, die es wasserdicht macht. Das mit Polyurethan verbundene Teil darf nicht der Sonne ausgesetzt werden. Auf Anfrage mit Mindestmenge auf Sunbrella® Polyacryl Gewebe anwendbar.

tessuto acrilico stampato



Fibra acrilica 100% stampa digitale. Solidità alla luce 6. Lavabile a 30°.
100% acrylic fiber with digital print. 6 light fastness. Washable at 30°.
100% fibre acrylique impression numérique. Résistance à la lumière 6. Lavable à 30°.
100% Polyacrylfaser mit Digitaldruck. Lichtechtheit 6. Waschbar bei 30°.
100% fibra acrilica impresión digital. Solidez a la luz 6. Lavable a 30°.



tropical .081
190 gr/m²

TECH



50% vinile e 50% poliéster. Trattamento idrorepellente, antimacchia, antimuffa, ignifugo e antibatterico. Solidità alla luce 6. Lavare a mano in acqua fredda. Alla base dei cuscini seduta comodo TECH panama viene applicata una rete a maglia larga in poliéster per permettere la traspirazione.
50% vinyl and 50% polyester. The treatment makes the coating: water repellent, and resistant to staining, resistant to mold, fire retardant, and antibacterial. 6 light fastness. Hand wash in cold water. At the bottom of the Komodo seat cushions, made with TECH panama, the fabric is a polyester wide mesh to allow breathability.
50% vinyle et 50% polyester. Traitement imperméable, anti-taches, anti-moisissures, ignifugé et antibactérien. Résistance à la lumière 6. Laver à la main à l'eau froide. À la base des coussins d'assise comodo TECH panama, un filet de polyester à larges mailles est appliqué pour évacuer la transpiration.
50% Vinyl und 50% Polyester. Wasserabweisend, gegen Flecken und Schimmelbildung ausgerüstet, feuerfest und antibakteriell. Lichtechtheit 6. Handwäsche in kaltem Wasser. Auf der Unterseite der TECH panama Komodo-Sitzkissen ist ein atmungsaktives Polyesternetz mit großer Maschenweite angebracht, um Luftaustausch zu ermöglichen.



TECH panama .131
830 gr/m²

El tejido está acoplado internamente con una película de poliuretano que lo hace impermeable. La parte acoplada de poliuretano no debe exponerse al sol. Aplicable bajo pedido con una cantidad mínima en tejidos acrílicos Sunbrella®.
O tecido é dublado com filme interno de poliuretano que o torna impermeável. O lado que possui o filme de poliuretano não pode ser exposta ao sol. Aplicável sob encomenda, com quantidade mínima, em tecidos acrílicos Sunbrella®.
Kumaş, su geçirmez hale getiren bir poliüretan film ile dahili olarak birleştirilmiştir. Birleştirilmiş poliüretan bölümler güneşe maruz bırakılmamalıdır. Sunbrella® akrilik kumaşlar üzerine minimum miktarda istek üzerine uygulanabilir.
Ткань внутренне соединена с полиуретановой пленкой, которая делает ее водонепроницаемой. та часть где имеется добавка полиуритана не выставлять на солнце. Применяется по запросу с минимальным количеством на акриловых тканях Sunbrella®.

100% fibra acrilica estampa digital. Resistência à luz 6. Lavável a 30°.
%100 dijital baskı akrilik elyaf. Işık hızlığı 6. 30°de yıkanabilir.
100% акриловое волокно с цифровым рисунком, окрашенное в процессе производства. Светостойкость 6. Стирка при 30°.

cuscinò Trill termoformato



Tessuto Sunbrella® Terry: 76% fibra acrilica Sunbrella® tinto in massa e 24% poliestere. Trattamento antimacchia, antimuffa. Solidità alla luce 7/8. Senza cuciture. Lavabile a 30°. Imbottitura: poliuretano espanso rivestito da una membrana TPU waterproof. Densità 40 kg/m³. Sunbrella® Terry Fabric: 76% Sunbrella® acrylic fiber mass dyed and 24% polyester. Dirt repellent and anti-mould treatment. 7/8 light fastness. Seamless. Washable at 30°. Padding: polyurethane foam with a TPU waterproof membrane coating. Density 40 kg/m³. Sunbrella® Terry Tissu: 76% fibre acrylique Sunbrella® teintée en masse et 24% polyester. Traitement anti-taches et anti-moisissure. Résistance à la lumière 7/8. Sans couture. Lavable à 30°. Rembourrage: mousse polyuréthane revêtu d'une membrane TPU imperméable. Densité 40 kg/m³.

Sunbrella® Terry Gewebe: 76% fasergefärbtes Polyacryl Sunbrella® und 24% Polyester. Gegen Flecken und Schimmel Ausrüstung. Lichtechtheit 7/8. Ohne Nähte. Waschbar bei 30°. Polsterung: Polyurethanschaum mit einer wasserdichten TPU-Membran abgedeckt. Dichte 40 kg/m³.



cenere .132
550 gr/m²

Tejido Sunbrella® Terry: 76% fibra acrilica Sunbrella® tintada en masa y 24% poliester. Proteccion antimanchas, antimoho. Solidez a la luz 7/8. Sin costuras. Lavable a 30°. Relleno: espuma de poliuretano recubierto con una membrana de TPU impermeable. Densidad 40 kg/m³. Tecido Sunbrella® Terry: 76% fibra acrilica Sunbrella® tingida em massa e 24% poliéster. Tratamento antimancha e antimoho. Resistência à luz 7/8. Sem costuras. Lavável a 30°. Enchimento: espuma de poliuretano com cobertura de membrana TPU impermeável. Densidade 40 kg/m³.

Sunbrella® Terry Kumaş: %76 akrilik elyaf Sunbrella® çözümlü halindeyken boyanmış ve %24 polyester. Leke itici, küf önleyici ile muamele edilmiş. Işık haslığı 7/8. Dikişsiz. 30°de yıkanabilir. Dolgu malzemesi: TPU waterproof film ile kaplanmış poliüretan köpük. Yoğunluk 40 kg/m³.

Ткань Sunbrella® Terry: 76% акриловое волокно Sunbrella®, окрашенное в массе и 24% полиэстера. Пятноустойчивая и противоплесневая обработка. Светостойкость 7/8. Без швов. Стирать при 30°. Навивка: пенополиуретан с покрытием из водостойкой мембраны TPU. Плотность 40 кг/м³.

tessuto 100% Olefin



100% Olefin tinto in massa. Trattamento antimacchia, antimuffa. Solidità alla luce 7/8. Lavabile a 40°. 100% Olefin mass dyed. Dirt repellent and anti-mould treatment. 7/8 light fastness. Washable at 40°. 100% Olefin teintée en masse. Traitement anti-taches et anti-moisissure. Résistance à la lumière 7/8. Lavable à 40°. 100% fasergefärbtes Olefin. Gegen Flecken und Schimmel Ausrüstung. Lichtechtheit 7/8. Waschbar bei 40°.

100% Olefin tintada en masa. Proteccion antimanchas, antimoho. Solidez a la luz 7/8. Lavable a 40°.

100% Olefin tingida em massa. Tratamento antimancha e antimoho. Resistência à luz 7/8. Lavável a 40°.

%100 Olefin çözümlü halindeyken boyanmış. Leke itici, küf önleyici ile muamele edilmiş. Işık haslığı 7/8. 40°de yıkanabilir.

100% Olefin, окрашенный в массе. Пятноустойчивая и противоплесневая обработка. Светостойкость 7/8. Стирать при 40°.



bianco .155
190 gr/m²



caffè .165
190 gr/m²

tessuto 100% Olefin idrorepellente



100% Olefin tinto in massa. Trattamento con resina poliuretanica/acrilica, idrorepellente. Solidità alla luce 7/8. Lavabile a 40°.

100% Olefin mass dyed. Treatment with polyurethane/acrylic resin, water-repellent. 7/8 light fastness. Washable at 40°.

100% Olefin teintée en masse. Traitement avec une résine de polyuréthane acrylique, imperméable. Résistance à la lumière 7/8. Lavable à 40°.

100% fasergefärbtes Olefin. Ausrüstung mit Polyurethan-Harz/Polyacryl, wasserabweisend. Lichtechtheit 7/8. Waschbar bei 40°.



écru .160
220 gr/m²



blu .076
220 gr/m²

100% Olefin tintada en masa. Tratamiento con resina de poliuretano/acrílica, repelente al agua. Solidez a la luz 7/8. Lavable a 40°.

100% Olefin tingida em massa. Tratamento com resina de poliuretano acrílico, hidrorrepelente. Resistência à luz 7/8. Lavável a 40°.

100% Olefin çözümlü halindeyken boyanmış. Poliüretan reçine/akrilik ile muamele edilmiş, su itici. Işık haslığı 7/8. 40°de yıkanabilir.

100% Olefin, окрашенный в массе. Обработка полиуретановым/акриловым полимером, водоотталкивающая. Светостойкость 7/8. Стирать при 40°.

imbottitura

CUSCINO FOLIO COMFORT

Poliuretano espanso (densità 18 kg/m³) rivestito da fibra di poliestere accoppiata al tessuto. Polyurethane foam (density 18 kg/m³) with a polyester fiber coating bonded to the fabric. Mousse polyuréthane (densité 18 kg/m³) revêtu de fibre de polyester couplé au tissu. Polyurethanschaum (Dichte 18 kg/m³) mit Polyesterfasern beschichtet, gekoppelt mit dem Gewebe. Espuma de poliuretano (densidade 18 kg/m³) cubierta con fibras de poliéster acoplada ao tecido. Kumaşa birleştirilmiş polyester elyafı ile kaplanmış genişletilmiş poliüretan (yoğunluk 18 kg/m³). Расширенный полиуретан (плотность 18 кг/м³), покрытый полиэфирным волокном, соединенным с тканью.

CUSCINO NET BENCH - CUSCINO NET RELAX - CUSCINO NET - CUSCINO FIT ARIA - CUSCINO ACQUAMARINA - CUSCINO DARSENA

Poliuretano espanso. Densità 28 kg/m³. Polyurethane foam. Density 28 kg/m³. Mousse polyuréthane. Densité 28 kg/m³. Polyurethanschaum. Dichte 28 kg/m³. Espuma de poliuretano. Densidad 28 kg/m³. Espuma de poliuretano. Densidade 28 kg/m³. Poliüretan köpük. Yoğunluk 28 kg/m³. Пенополиуретан. Плотность 28 кг/м³.

CUSCINO SEDUTA ARIA

Poliuretano espanso. Densità 25 kg/m³. Polyurethane foam. Density 25 kg/m³. Mousse polyuréthane. Densité 25 kg/m³. Polyurethanschaum. Dichte 25 kg/m³. Espuma de poliuretano. Densidad 25 kg/m³. Espuma de poliuretano. Densidade 25 kg/m³. Poliüretan köpük. Yoğunluk 25 kg/m³. Пенополиуретан. Плотность 25 кг/м³.

CUSCINO SHELL NET RELAX

Poliuretano espanso su struttura rigida di polipropilene. Densità 70 kg/m³. Polyurethane foam over solid polypropylene frame. Density 70 kg/m³. Mousse polyuréthane sur structure rigide de polypropylène. Densité 70 kg/m³. Polyurethanschaum auf steifer Polypropylengestell. Dichte 70 kg/m³. Espuma de poliuretano sobre estructura rígida de polipropileno. Densidad 70 kg/m³. Espuma de poliuretano sobre estrutura rígida de polipropileno. Densidade 70 kg/m³. Sert polipropilen gövde üzerinde poliüretan köpük minder. Yoğunluk 70 kg/m³. Пенополиуретан, на жесткой конструкции из полипропилена. Плотность 70 кг/м³.

CUSCINO PASSEPARTOUT - CUSCINO RETTANGOLARE

Fibra di poliestere. Polyester fiber. Fibre de polyester. Polyesterfasern. Fibras de poliéster. Fibras de poliéster. Polyester elyaf. Обшивка из полиэстера.

CUSCINO SEDUTA KOMODO - CUSCINO ARREDO ARIA

Poliuretano espanso (densità 25 kg/m³) rivestito da fibra di poliestere (densità 450 gr/m²). Polyurethane foam (density 25 kg/m³) with a polyester fiber coating (density 450 gr/m²). Mousse polyuréthane (densité 25 kg/m³) revêtu de fibre de polyester (densité 450 gr/m²). Polyurethanschaum (Dichte 25 kg/m³) mit Polyesterfasern beschichtet (Dichte 450 gr/m²). Espuma de poliuretano (densidad 25 kg/m³) cubierta con fibras de poliéster (densidad 450 gr/m²). Espuma de poliuretano (densidade 25 kg/m³) com cobertura fibras de poliéster (densidade 450 gr/m²). Polyester elyaf (Yoğunluk 450 gr/m²) kaplı köpük poliüretan (Yoğunluk 25 kg/m³). Пенополиуретан (Плотность 25 кг/м³) с покрытием из обшивки из полиэстера (Плотность 450 гр/м²).

CUSCINO SCHIENALE KOMODO - CUSCINO SCHIENALE ANGOLO KOMODO

Poliuretano espanso (densità 21 kg/m³) rivestito da fibra di poliestere (densità 450 gr/m²). Polyurethane foam (density 21 kg/m³) with a polyester fiber coating (density 450 gr/m²). Mousse polyuréthane (densité 21 kg/m³) revêtu de fibre de polyester (densité 450 gr/m²). Polyurethanschaum (Dichte 21 kg/m³) mit Polyesterfasern beschichtet (Dichte 450 gr/m²). Espuma de poliuretano (densidad 21 kg/m³) cubierta con fibras de poliéster (densidad 450 gr/m²). Espuma de poliuretano (densidade 21 kg/m³) com cobertura fibras de poliéster (densidade 450 gr/m²). Polyester elyaf (Yoğunluk 450 gr/m²) kaplı köpük poliüretan (Yoğunluk 21 kg/m³). Пенополиуретан (Плотность 21 кг/м³) с покрытием из обшивки из полиэстера (Плотность 450 гр/м²).

CUSCINO EDEN

Poliuretano espanso. Densità 18 kg/m³. Polyurethane foam. Density 18 kg/m³. Mousse polyuréthane. Densité 18 kg/m³. Polyurethanschaum. Dichte 18 kg/m³. Espuma de poliuretano. Densidad 18 kg/m³. Espuma de poliuretano. Densidade 18 kg/m³. Poliüretan köpük. Yoğunluk 18 kg/m³. Пенополиуретан. Плотность 18 кг/м³.

tessuto sintetico

Tessuto in filo di poliestere rivestito in pvc. Fabric is made of a polyester fiber, with a pvc coating. Tissu en fil de polyester revêtu de pvc. Gewebe aus PVC-ummantelten Polyesterfasern. Tejido en hilo de poliester recubierto de pvc. Tecido de fibra polyester com cobertura pvc. PVC kaplı polyester elyaf tekstil. Ткань из полиэфирных нитей с покрытием из ПВХ.



bianco .107
tela 1x1

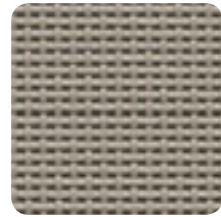

tortora .104
tela 1x1

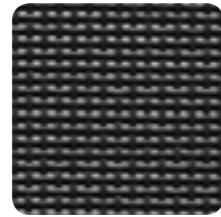

antracite .057
tela 1x1

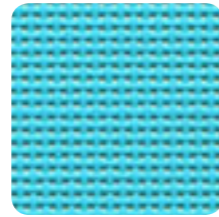

celeste .075
tela 1x1

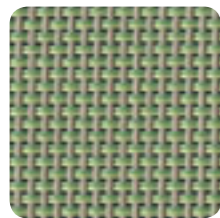

agave .101
tela 2x1

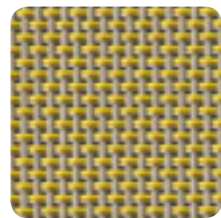

deserto .103
tela 2x1



bianco .108
tela 2x2



beige .115
tela 2x2



tortora .124
tela 2x2

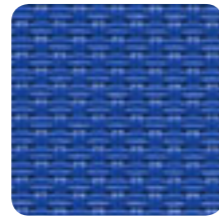

blu .112
tela 2x2

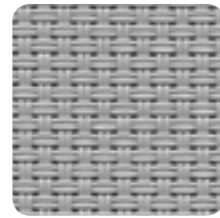

grigio .086
tela 2x2



trama caffè .117

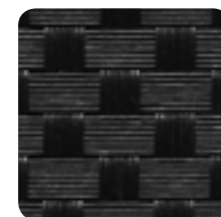

trama antracite .116

alluminio

verniciato

La verniciatura è a polvere di poliestere. The painting is with polyester powder. La peinture est à poudre de polyester. Die Epoxierung erfolgt mit Polyesterpulver. El pintado

se realiza con polvo de poliéster. O pó de poliester è usado para envernizar. Boyası polyester tozla yapılır. Окраска производится при помощи порошкового полиэстера.

verniciato - trattamento speciale

Trattamento speciale per ambienti ad alto tasso salino. Special treatment for high salinity environments. Traitement spécial pour les environnements a haute salinité. Sonderbehandlung für Ambiente mit hohem Salzgehalt. Tratamiento especial para ambientes con alta

salinidad. Tratamiento especial para ambientes com alto teor de sal. Yüksek tuza maruz kalan alanlar için özel bakım. Специальная обработка для среды с высоким содержанием соли.



verniciato bianco .53



verniciato argento .54



verniciato antracite .52



verniciato burro .58



verniciato tortora .59



verniciato caffè .57



verniciato agave .66

laminato HPL

Laminato decorativo ad alta pressione, compatto, omogeneo, non poroso, ad alta densità.
Decorative high pressure laminate, solid, homogeneous, non-porous and with a high density.
Stratifié décoratif à haute pression, condensé, homogène, pas poreux, haute densité.
HPL-Laminat, beständig, homogen, hoch verdichtet.
Laminado decorado a alta presión, compacto, homogéneo, no poroso y de alta densidad.

Decorativo e laminado a alta pressão, sólido, homogéneo, não poroso e de grande densidade.
Dekoratif yüksek basınçlı laminat, masif, gözeneksiz ve yüksek yoğunluklu.
Декоративный ламинат высокого давления, компактный, однородный, непористый, с высокой плотностью.



BIANCO .301
sp. 12 mm



GRIGIO .300
sp. 12 mm

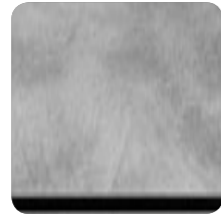

CEMENTO .305
sp. 12 mm



ANTRACITE .303
sp. 12 mm



TORTORA .310
sp. 12 mm



LEGNO .311
sp. 12 mm



CORTEN .312
sp. 12 mm



CAFFÈ .302
sp. 12 mm



AGAVE .316
sp. 10 mm

laminato HPL Solid Core

Laminato decorativo ad alta pressione, compatto, omogeneo, non poroso, ad alta densità.
Decorative high pressure laminate, solid, homogeneous, non-porous and with a high density.
Stratifié décoratif à haute pression, condensé, homogène, pas poreux, haute densité.
HPL-Laminat, beständig, homogen, hoch verdichtet.
Laminado decorado a alta presión, compacto, homogéneo, no poroso y de alta densidad.

Decorativo e laminado a alta pressão, sólido, homogéneo, não poroso e de grande densidade.
Dekoratif yüksek basınçlı laminat, masif, gözeneksiz ve yüksek yoğunluklu.
Декоративный ламинат высокого давления, компактный, однородный, непористый, с высокой плотностью.



TOTAL WHITE .314
sp. 10 mm

Fenix NTM®/Solid



NERO FENIX NTM® .313
sp. 10 mm

vetro

Vetro float temperato serigrafato e vetrificato a 700°C. Spessore 10 mm.
Tempered Float glass, screen-printed and vitrified at 700° C. 10 mm thick.
Verre float trempé sérigraphié et vitrifié à 700°C. Epaisseur 10 mm.
Sicherheitsglas mit innenliegendem Dekorsiebdruck, verglast bei 700°. Dicke 10 mm.

Vidrio float, templado, serigrafiado y vetrificado a 700°C. Espesor 10 mm.
Vidro float temperado, impresso e vetrificado a 700°C. Espessura 10 mm.
Temperli, üstü baskılı ve 700° C vitrifiye edilmiş. Kalınlık 10 mm.
Сериграфированное закаленное стекло float, производимое при 700°C. Толщина 10 мм.



BIANCO .00



ANTRACITE .02

vetro

Vetro extrachiaro temperato. Spessore 6 mm.
Extra-clear tempered glass. 6 mm thick.
Verre trempé extra clair. Epaisseur 6 mm.
Extra klares gehärtetes Glas. Dicke 6 mm.

Vidrio templado extra claro. Espesor 6 mm.
Vidro temperado extra claro. Espessura 6 mm.
Ekstra net temperli cam. Kalınlık 6 mm.
Особо прозрачное закаленное стекло. Толщина 6 мм.

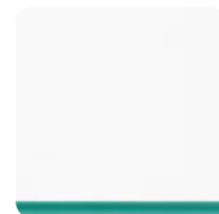

vetro .501

durelTOP



DurelTOP è un sistema innovativo di produzione di piani per tavoli studiati per raggiungere i più elevati livelli di praticità, resistenza, robustezza ed eleganza. I piani DurelTOP sono ad alto spessore, formati da un doppio strato tamburato perfettamente chiuso. Prodotti in polipropilene di prima qualità, sono inalterabili all'acqua, resistenti al sole e facili da pulire. DurelTOP è il risultato di una lunga ricerca tecnologica e dell'esperienza decennale nella lavorazione delle materie plastiche della NARDI, da sempre all'avanguardia nell'ambiente contract e giardino.

The DurelTOP is an innovative new system in the production of tabletops developed to reach the highest levels of practicality, resistance, and elegance. The DurelTOP tabletops have a greater thickness, formed by a double layer enclosure perfectly closed. Produced in first quality polypropylene, they are resistant to water, resistant to sunlight, and are easy to clean. DurelTOP is a result of a decade's long research and development in plastics by Nardi, always a leader in the contract and garden sectors.

DurelTOP est un système innovateur de production de plateaux de tables, il est étudié pour retrouver le meilleur niveau de pratique de résistance et d'élégance. Les plateaux DurelTOP sont très épais, formés de doubles couches parfaitement finies. Ce sont des produits en polypropylène de première qualité, ils sont inaltérables à l'eau, résistant au soleil et faciles à nettoyer. DurelTOP est le résultat d'une longue recherche technologique et une expérience décennale dans le travail des matières plastique de la Sié NARDI, toujours à l'avant-garde dans le secteur du contract et jardin.

DurelTOP ist ein neu entwickeltes System für die Produktion von Tischplatten, um ein Höchstmaß an Funktionalität, Widerstandsfähigkeit und Eleganz zu erreichen. Durch das innen verstärkte "Zwei-Schichten-Hohlraum-System" erreicht die DurelTOP Tischplatte einen stärkeren Querschnitt und damit ein Höchstmaß an Festigkeit. Hergestellt aus hochwertigem Qualitätspolypropylen ist sie resistent gegen Wasser und Sonnenlicht und dabei leicht zu reinigen. DurelTOP ist das Ergebnis von 10 Jahren Forschung und Entwicklung auf dem Kunststoffsektor durch Nardi, immer der führende im Bereich Contract- und Gartenmöbel.

DurelTOP es un nuevo sistema de fabricación de tableros de mesa estudiado para alcanzar los mas altos niveles de practicidad, resistencia, robustez y elegancia. Los tableros DurelTOP de gran solidez, estan formados por una doble capa perfectamente unida y sellada. Fabricados en polipropileno de primera calidad son inalterables al agua, resistentes al sol y de fácil limpieza. DurelTOP es el resultado de una prolongada investigación tecnológica y de la experiencia acumulada en los mas de diez años que Nardi lleva produciendo materias plasticas, siempre innovando en ambientes contract y jardín.

DurelTOP é um sistema de inovação da produção de tampos de mesa concebidos para atingir a máxima resistência, práticos e elegantes. Os tampos de mesa DurelTOP são formados por uma camada dupla e perfeitamente unida. Produzidos em polipropileno de primeira qualidade, são resistentes ao sol e fáceis de limpar. DurelTOP é o resultado de uma longa investigação tecnológica em materiais plásticos da Nardi, leader em mobiliário de jardim.

DurelTOP, masa tablalarının üretiminde kullanılan yeni bir sistem olup, yüksek seviyede pratiklik, direnç ve de şıklık sunmak amacıyla geliştirilmiştir. DurelTOP masa tablaları fevkalade bir inceliğe sahip olup, kusursuz kapanan çift tabaka çevirme sistemiyle oluşturulmuştur. Nitelikli çamsakızdan üretilmiş olup, suya ve güneş ışığına karşı dirençli ve temizlenmesi kolaydır. DurelTOP sistemini Contract ve de Bahçe sektöründe her zaman lider olan Nardi'nin uzun araştırmalarının sonucundan doğan, plastikte gelişim olarak adlandırabiliriz.

DurelTOP — это инновационная система производства столешниц, позволяющая изготавливать практичные, прочные, крепкие и элегантные столешницы. Столешницы DurelTOP обладают высокой плотностью и состоят из двойной панели с мелкопустотным заполнением, полностью закрытой. Изделия из полипропилен высокого качества устойчивы к воде, солнцу и просты в уходе. DurelTOP — это результат многолетних технологических исследований и десятилетнего опыта NARDI в обработке пластмасс, лидера в производстве садовой мебели и контрактном секторе.

vivax IRODABÚTOR



1138 Budapest, Váci út
144-150. (Váci Corner)
Tel. +36 1 611 7646
Fax . +36 1 611 7647
Mobil. +36 30 985 9283
Email. budapest@vivax.hu

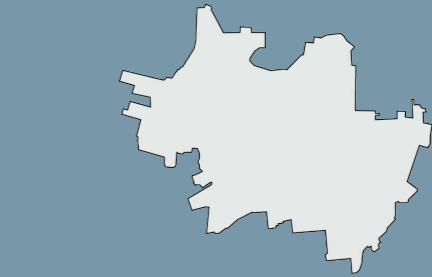

4031 Debrecen, István utca 6.
Tel. +36 52 524 540
Fax. +36 52 524 541
Mobil. +36 70 671 0377
Email. vivax@vivax.hu,
tervezes@vivax.hu



2045 Törökbálint, Tópark utca 1/a.
(MaxCity Lakberendezési
Áruház, II. em. 232.)
Tel . +36 23 444 707
Fax . +36 23 444 708
Mobil. +36 30 968 5232
Email. budapest@vivax.hu

3525 Miskolc, Széchenyi utca 99.
Tel. +36 46 413 920
Fax. +36 46 413 921
Mobil. +36 30 903 9255
Email. vivaxmiskolc@vivax.hu

 impilabile stackable empilable stapelbar apilable empilhável istiflenebilir стекируемые

 impilabile orizzontalmente stackable horizontally piètement encastrable lneinander stapelbar apilable horizontalmente empilhável horizontalmente yatay olarak istiflenebilir горизонтальная расстановка

 pieghevole folding pliant klappbar plegable dobrável katlanabilir складывающийся

 reclinabile reclining dossier réglable verstellbare Rückenlehne reclinable reclinável sırt pozisyonlu откидной

Tutte le sedute sono dotate di piedini antiscivolo. All chairs are equipped with non-slip feet. Tous les sièges sont équipés avec patins anti-dérapants. Alle Stühle sind mit rutschfesten Fußkappen ausgestattet. Todos los asientos están equipados con tapones antideslizantes. Bütün sandalyeler kaymaz ayaklıdır. Ножки всех стульев оснащены противоскользящей резиновой подложкой.

Sui colori scuri, ombre ed altri difetti minori sono più evidenti rispetto ai colori chiari e sono da ritenersi standard. On dark colors, shadows and other minor faults are more evident than on lighter colors and are therefore standard. Sur les couleurs sombres, les ombres et les autres petits défauts sont plus marqués que sur les couleurs claires et sont tout à fait standards. Auf dunklen Farben sind Schatten und andere kleinere Mängel sichtbarer als auf hellen Farben und sind daher als Standard zu betrachten. Las sombras y demás defectos menores son más evidentes sobre los colores oscuros respecto a los colores claros y tienen que considerarse como estándares. Em cores escuras, sombras e outros defeitos menores são mais evidentes do que em cores claras e devem ser considerados standard. Koyu renkler üzerinde, gölgeler ve diğer küçük defolar açık renkler üzerinde olduklarından daha belirginleşmekte ve bu nedenle normal olarak değerlendirilmelidir. По сравнению со светлыми цветами на темных цветах тени и другие небольшие дефекты более заметны и должны считаться нормой.

Il peso (kg), le misure (cm) e i colori riportati sono indicativi. La NARDI si riserva il diritto di apportare modifiche o varianti senza preavviso. Tutti i modelli sono depositati. Weights (kg), dimensions (cm) and colors are indicative only. NARDI reserves the right to make changes or variations without notice. All models are patented. Le poids (kg), les dimensions (cm) et les couleurs indiqués sont fournis purement à titre indicatif. La Firma NARDI se réserve le droit d'apporter toute modification ou variation sans aucun préavis. Tous les modèles sont déposés. Alle Farb-, Maß- (cm) und Gewichtsangaben (kg) sind nicht als fest bindend anzusehen Firma NARDI behält sich das Recht von Änderungen Alle Modelle sind gesetzlich geschützt. El peso (kg), las medidas (cm) y los colores detallados, son indicativos. La firma NARDI se reserva el derecho de modificaciones o variaciones sin previo aviso. Todos los modelos llevan nuestra marca. O peso (kg), as medidas (cm) e as cores indicadas, são indicativos. A NARDI reservase o direito de aportar modificações ou variações sem préaviso. Todos os modelos estão depositados. Ağırlık (Kg), boyutlar (cm) ve renkler gösterme amaçlıdır. NARDI'nin önceden bildirmeden değişiklik yapma hakkı vardır. Bütün modeller patentlidir. Приведенный вес (кг), размеры (см) и цвета являются ориентировочными. Компания NARDI оставляет за собой права вносить изменения и вариации без предварительного предупреждения. Все модели зарегистрированы.



10101116