

BOXI

Technical information



Other documents available for this product

NARBUTAS product care guide

Quality standard

EN 14073-2:2004
EN 14073-3:2004
EN 14074:2004

10 year Warranty

See Warranty statement



Technical information

Carcass

Made of 16 mm MFC (melamine) with 1 mm edging;
Made of 18 mm MFC (melamine) with 1 mm edging;
Made of 25 mm MFC (melamine) with 2 mm edging (only for H=740 mm top and H=1090 mm middle top).
Handle type Z.

Pull-out drawer (1)

Made of 18 mm MFC (melamine) with 1 mm edging (except file tower, and towers which are 360 mm width, there are parts which are made of 16 mm MFC (melamine));
Soft closing function;
Lockable;
Load max. 50 kg;
Plastic pen holder is integrated in the upper shelf.

Legs

Four plastic height levelling feet, H=23 mm (+10 mm);
1 castor Ø80 mm (tread from thermoplastic rubber, non-marking).

Sliding doors

Made of 10 mm plywood with laminate, edges – lacquered;
No handles (just cut-outs);
White plastic slide profile.

Inner file drawers

Made of 12 mm MFC (melamine) with 1 mm edging;
Full extension ball bearing slides, which are visible;
Height – 280 mm, depth – 350 mm, width – 646 mm;
Convenient opening without handles.

Inner personal drawers

Made of 12 mm MFC (melamine) with 1 mm edging;
Full extension ball bearing slides, which are visible;
Height – 120 mm, depth – 300 mm, width – 450 mm;
Convenient opening without handles.

Fixed metal shelves (2)

Made of 1 mm thick steel sheet;
Powder coated metal;
Fixed with screws.

USB fast charger

A+C Twin USB Fast Charger integrated into the back panel of the cabinet;
Hardwired power cord to GST18-3 800 mm;
Cable length: 3 m;
Dimensions: Ø74x50 mm;
Cable standard: UK, EU, CH, FR, US;
R letter means that if the port is damaged, you can change it without replacing the whole socket;
Black plastic.

Power socket

1 AC power socket 100 – 230 V;
 Hardwired power cord to GST18-3 800 mm;
 Cable length: 3 m;
 Dimensions: Ø74x50 mm, hole for socket Ø60 mm;
 Power socket standards: UK, EU, CH, FR, US;
 Black plastic.

Hook for clothes (3)

Dimensions: 20x28, H=62 mm;
 Powder coated metal;
 Fixed with screws.

Felt-lined inserts (4)

For towers with metal shelves;
 2 sizes: 671x198x2 mm, 450x343x2 mm;
 Suitable with ERA, LUCIA, VELITO PRESTO, SYNERGY;
 Optional, need to be ordered separately.

Optional



Drawer's box (1)

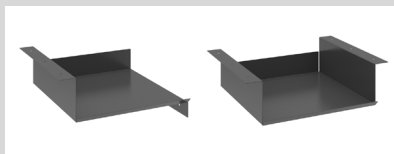

Metal shelves (right / central) (2)



Metal hook for clothes (3)

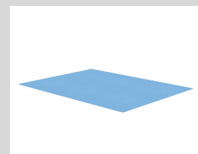

Felt-lined inserts (4)



Master key

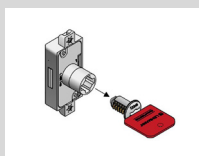

Removal key



Cylinder lock with 2 keys

Range

Towers*

*R/H or L/H option available

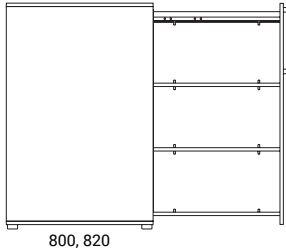
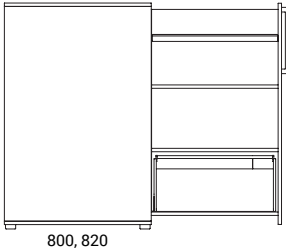
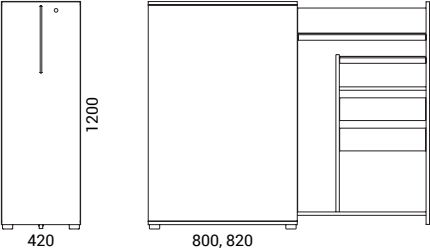
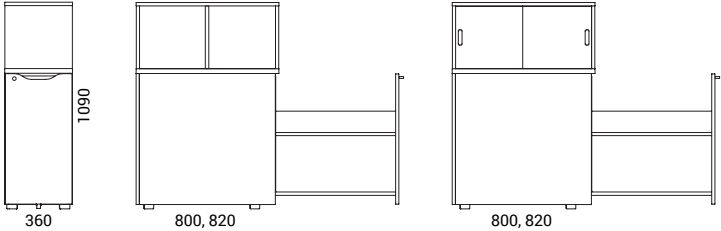
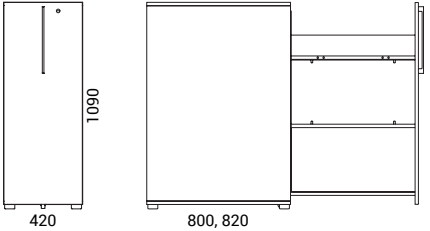
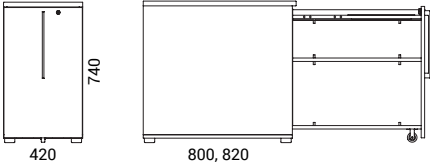

Bookcase

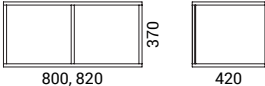

Planter Box

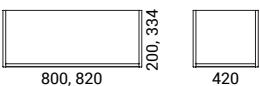

Additional information



Bookcase or plant box fixing. For fixing bookcase or plant box onto the tower please use stickers and follow the assembly scheme (included in the package).



Planter box care. Please note that the inner part of planter box is not protected from the moisture. We recommend you to use the Melamine Cleaning and Care Instructions.

Changing tower sides. You can switch the inner wall side from R/H to L/H or vice versa for universal towers and towers assembled as R/H or L/H. Please use the special fittings and follow the assembly scheme (included in the package).

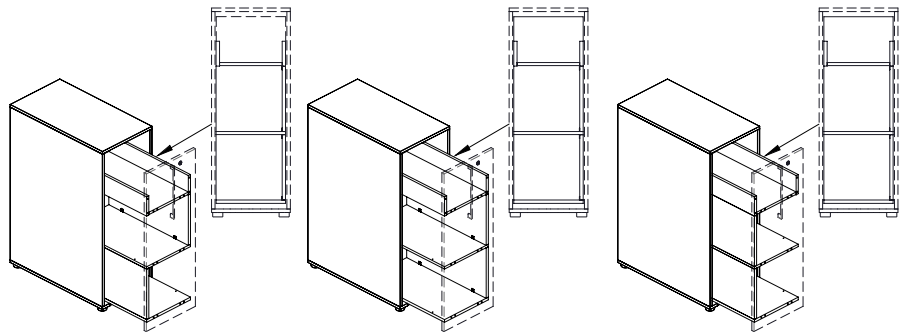

USB port/power socket cable management.

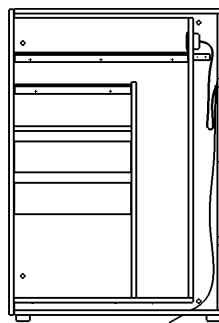

Closed

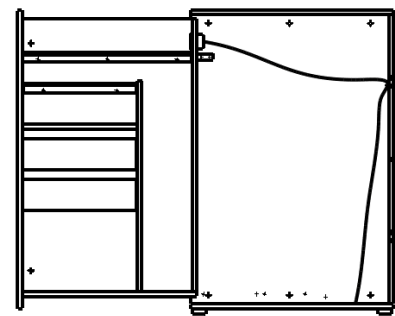

Open

Accessories fixing position

Fixing position of right metal shelf



* Suitable only for the upper shelf



* If you decide to switch sides from right or left, you will have to reassemble the shelves.

Fixing position of central metal shelf



* If you decide to switch sides from right or left, you will have to reassemble the shelves.

Fixing position of metal hook



Fixing position of drawer's box

