

ZEDO

Technical information



Other documents available for this product

Technical information for ZEDO desks

Technical information for ZEDO PET acoustic desk screens

Ordering guidelines for ZEDO desks

Cable management guidelines for ZEDO desks

Quality standard

· LST EN 15372:2017

Warranty

See Warranty Statement

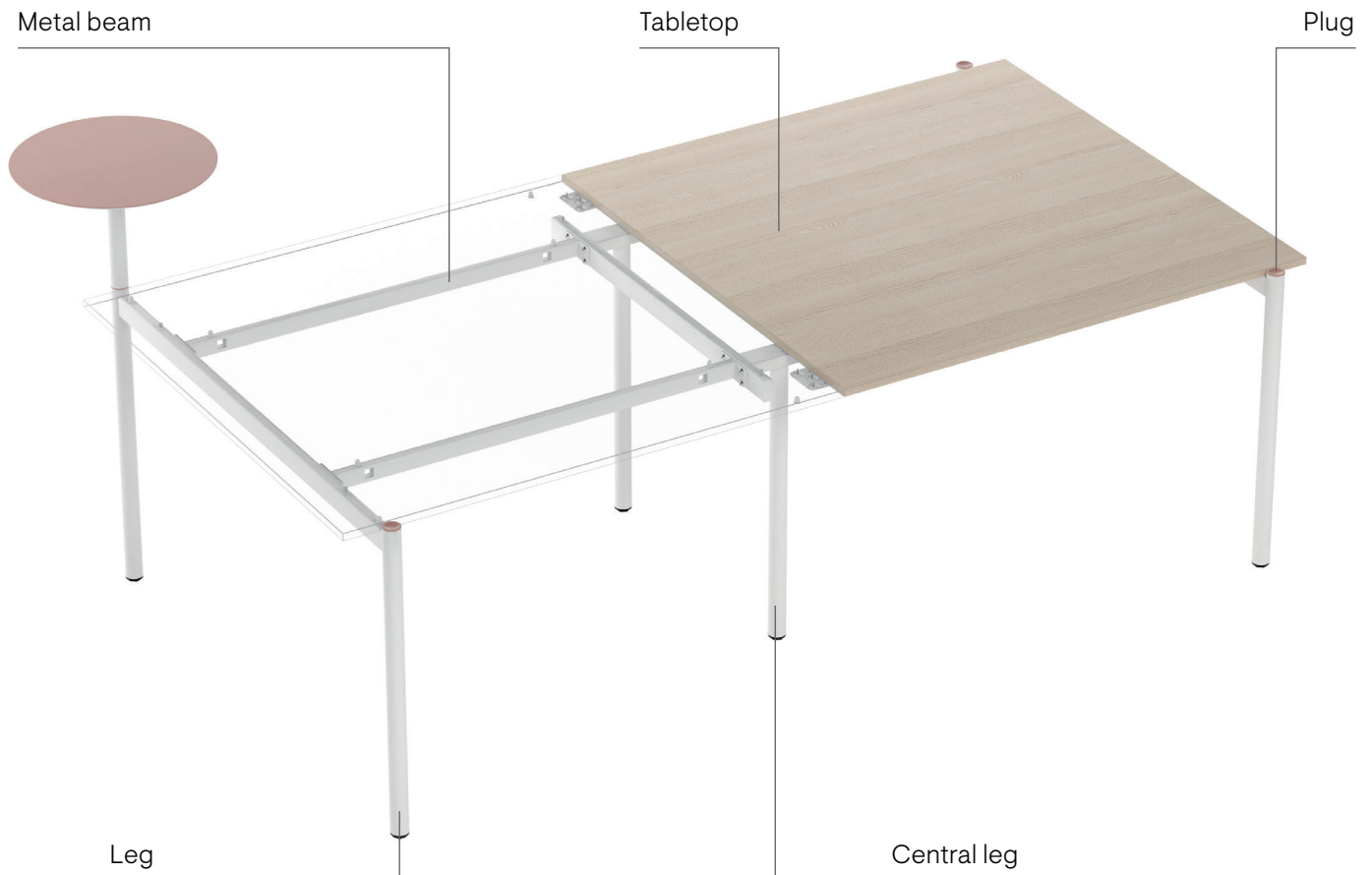

Technical information

Tabletop

- 18 mm MFC (melamine) with 1 mm ABS edges;
- Easy to assemble and disassemble - "metal-to-metal" construction.

Metal beam

- Metal tube – 40x20 mm;
- With welded metal plates for leg fixing;
- Powder coated metal.

Legs

- Welded metal structure of rectangular 50x25 mm and round Ø40 mm tubes;
- Powder coated metal;
- Plastic feet with height levelling (+10 mm).

Central leg

- Welded metal structure of rectangular 60x30 and 50x25 mm tubes;
- Vertical part – round Ø40 mm tube, assembled on site;
- Powder coated metal;
- Plastic feet with height levelling (+10 mm).

Plugs

- CNC machined metal, Ø40x13 mm;
- Powder coated metal;
- For desk legs without accessories plugs must be ordered separately.

Range

Conference & Meeting tables



6 seats

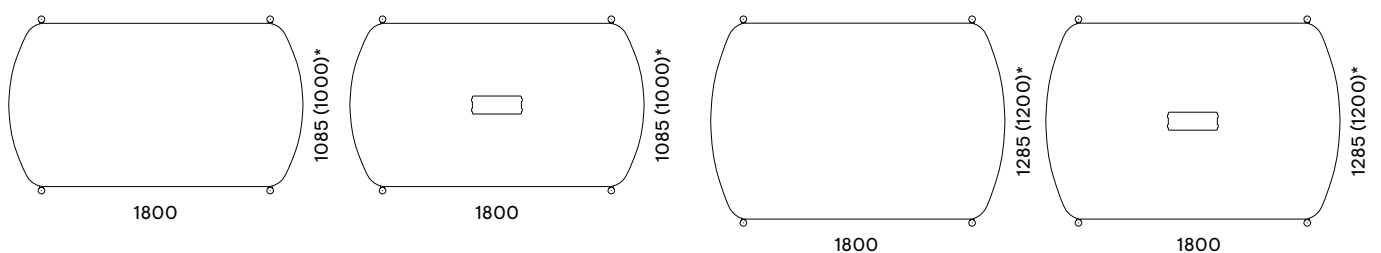

*Tabletop depth

Conference & Meeting tables

Supplementary units



4 seats

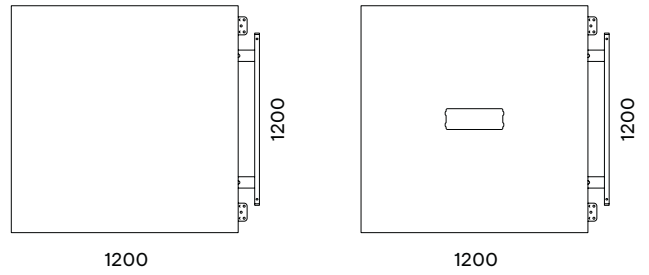
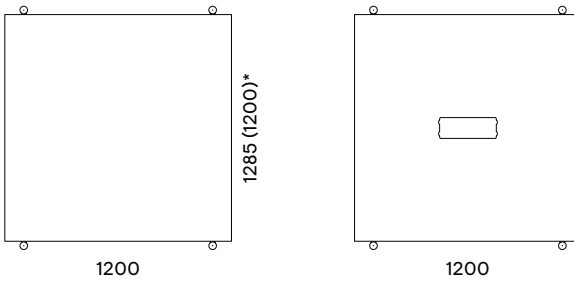
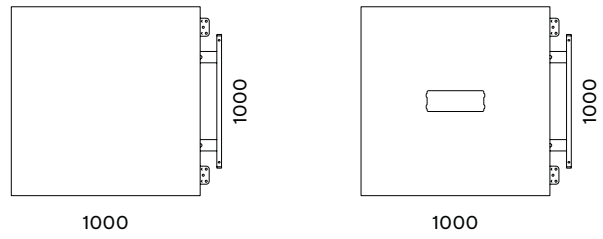
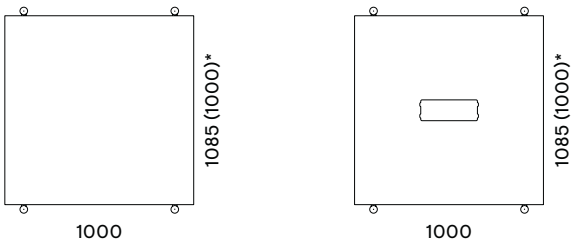

6 seats

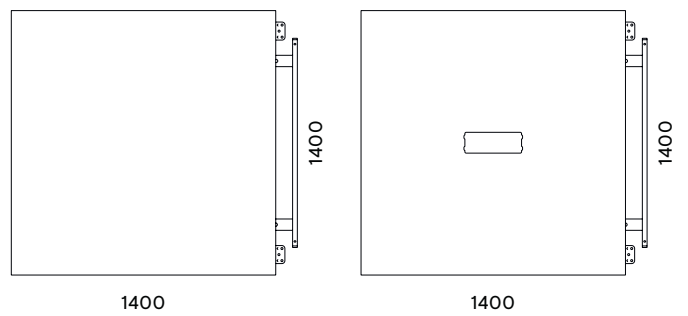
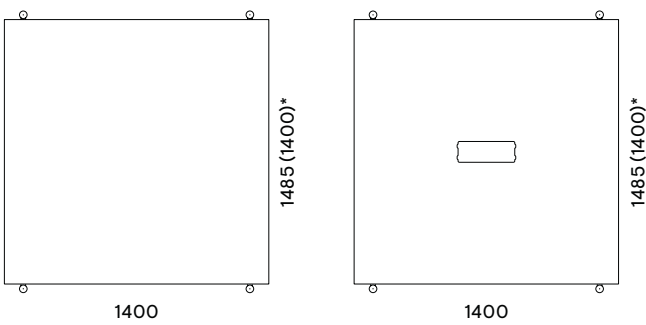

*Tabletop depth

Additional information

- You can use maximum three supplementary units in one combination to extend the table.



- Information about available accessories for this range can be found in our product pricelists.

ZEDO

Technical information



Other documents available for this product

Technical information for ZEDO conference & meeting tables

Technical information for ZEDO PET acoustic desk screens

Ordering guidelines for ZEDO desks

Cable management guidelines for ZEDO desks

Quality standard

LST EN 527-1:2011 (desks)

LST EN 527-2:2016 (desks)

LST EN 14073-2:2004 (storage)

LST EN 14073-3:2004 (storage)

LST EN 14074:2004 (storage)

Warranty

See Warranty Statement

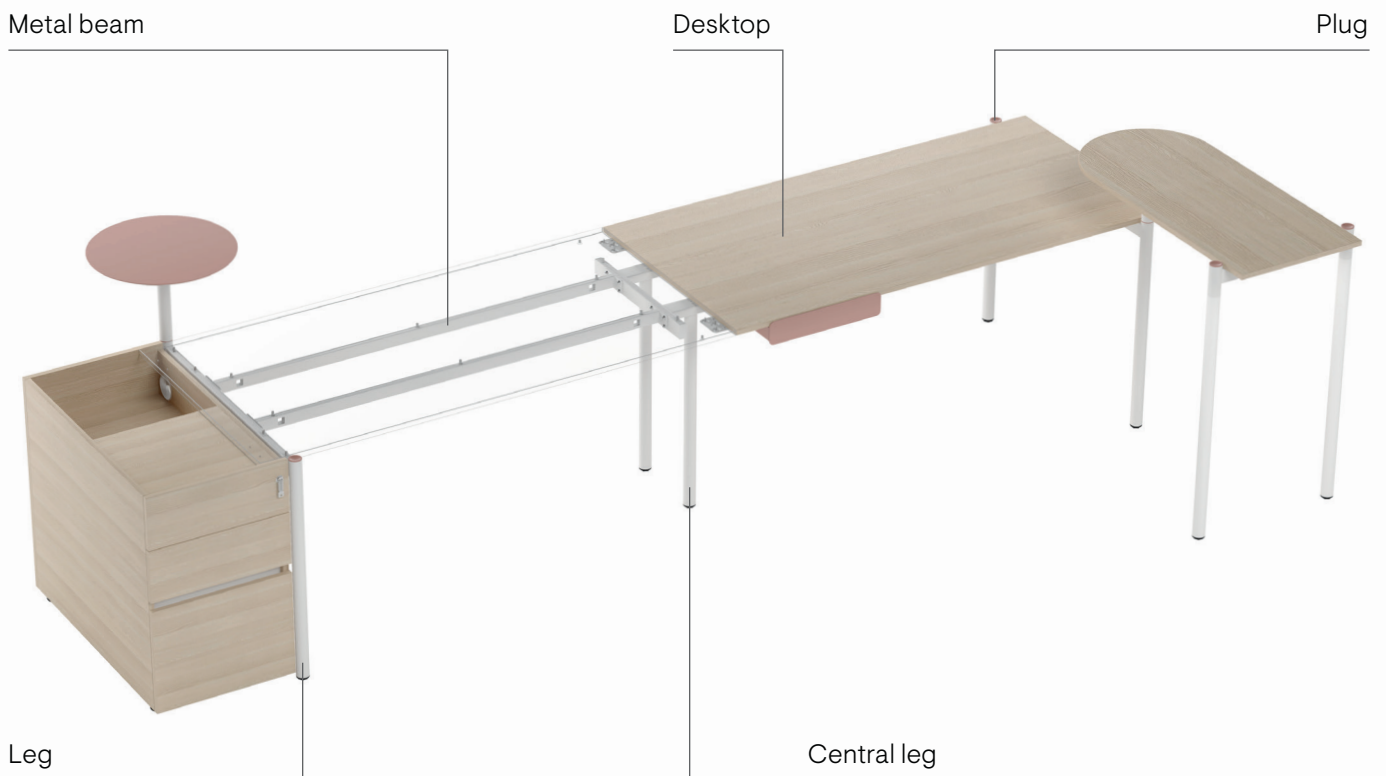

Technical information

Desks

Desktop

- 18 mm MFC (melamine) with 1 mm ABS edging;
- 45 mm gap between the desktops in back-to-back benches (depth of benches – 1530/1730 mm);
- Easy to assemble and disassemble - “metal to metal” construction.

Metal beam

- Metal tube – 40x20 mm;
- With welded metal plates for leg fixing;
- Powder coated metal.

Legs

- Welded metal structure of rectangular 50x25 mm and round Ø40 mm tubes;
- Powder coated metal;
- Plastic feet with height levelling (+10 mm).

Central leg

- Welded metal structure of rectangular 60x30 and 50x25 mm tubes;
- Vertical part – round Ø40 mm tube, assembled on site;
- Powder coated metal;
- Plastic feet with height levelling (+10 mm).

Plugs

- CNC machined metal, Ø40x13 mm;
- Powder coated metal;
- For desk legs without accessories plugs must be ordered separately.

High extension table

Desktop

- 18 mm MFC (melamine) with 1 mm ABS edging;
- 450 mm depth, one end rounded, R225.

Metal beam

- Metal tube – 40x20 mm;
- With welded metal plate and profile for leg fixing;
- Powder coated metal.

Legs

- Welded metal structure of rectangular 50x25 mm and round Ø40 mm tubes;
- Powder coated metal;
- Plastic feet with height levelling (+10 mm).

Fittings

- CNC machined metal, Ø40x13 mm;
- Powder coated metal.

Plugs

- CNC machined metal, Ø40x13 mm;
- Powder coated metal;
- For table legs without accessories plugs must be ordered separately.

Towers

Options

- Right side add unit (1)
- Left side add unit (2)
- Middle unit R/H (3)
- Middle unit L/H (4)

Carcass

- 18 mm MFC (melamine) with 1 mm ABS edging;
- Ø80 mm cut-outs in sides (middle unit only) for cable management;
- Ø80 mm cut-out cover made of plastic (white or black);
- Hooks for attaching to desk made of 3 mm sheet metal, powder coated;
- Dimensions: 450x739/839, H=741 mm.

Pull-out drawer

- 18 mm MFC (melamine) with 1 mm ABS edging;
- Convenient opening without handles;
- Plastic pen holder is integrated in the upper shelf;
- Soft closing function, lockable, full extension with hidden slides;
- Load capacity – 50 kg.

Legs

- Four plastic feet with height levelling, H=23 mm (+10 mm);
- Ø50 mm castor (tread from thermoplastic rubber, non-marking) for added drawer stability.

Inner File drawer (optional)

- Installed in bottom tower shelf;
- Suitable for A4 files (309 and 330 mm) or foolscap file (386 mm width);
- Always delivered unassembled;
- Drawer box made of 12 mm MFC (melamine) with 1 mm edging (ABS);
- Convenient opening without handles;
- Dimensions: 514x380, H=334 mm (outer), 446x323, H=233 mm (box, inner);
- Full extension ball bearing slides with roll-out prevention;
- Load capacity – 25 kg.

1



2



3



4



CPU pedestals

Options

- Right side add unit (1)
- Left side add unit (2)
- Middle unit (3)

Carcass

- 18 mm MFC (melamine) with 1 mm ABS edging;
- Ø80 mm cut-outs in sides and recess's bottom for various cable management situations;
- Ø80 mm cut-out cover made of plastic (white or black);
- Hooks for attaching to desk made of 3 mm sheet metal, powder coated;
- Dimensions: 450x739/839, H=741 mm;
- Load capacity – 25 kg.

Drawer

- Front made of 18 mm MFC (melamine) with 1 mm ABS edging;
- Box made of 16 mm MFC (melamine) with 1 mm ABS edging;
- Bottom made of 12 mm MFC (melamine);
- Convenient opening without handles;
- Soft closing function, lockable, full extension with hidden slides;
- Load capacity – 15 kg.

Legs

Four plastic feet with height levelling, H=23 mm (+10 mm).

1

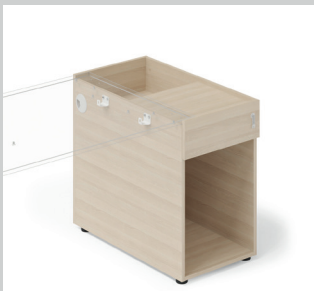

2



3



Three drawer pedestals

Options

- Right side add unit (1)
- Left side add unit (2)
- Middle unit (3)

Carcass

- 18 mm MFC (melamine) with 1 mm ABS edging;
- Ø80 mm cut-outs in sides for cable management;
- Ø80 mm cut-out cover made of plastic (white or black);
- Hooks for attaching to desk made of 3 mm sheet metal, powder coated;
- Dimensions: 450x739/839, H=741 mm;
- Load capacity – 25 kg.

Drawers

- Facade made of 18 mm MFC (melamine) with 1 mm ABS edging;
- Box made of 16 mm MFC (melamine) with 1 mm ABS edging;
- Bottom made of 12 mm MFC (melamine);
- Convenient opening without handles;
- Aluminium profile for middle and bottom drawers' opening, anodized (black only) or powder coated;
- Suitable for A4 files (309 and 330mm) or foolscap file (386 mm width);
- Soft closing function, lockable, full extension with hidden slides;
- Load capacity: top drawer – 15 kg, middle drawer – 15 kg, bottom drawer – 25 kg.

Legs

- Four plastic feet with height levelling, H=23 mm (+10 mm);
- Castor Ø32 mm (tread from thermoplastic rubber, non-marking) for file drawer.

1



2



3



Hanging two drawer pedestals (1)

Options

- Middle unit only

Carcass

- 18 mm MFC (melamine) with 1 mm ABS edging;
- Ø80 mm cut-outs in sides for cable management;
- Ø80 mm cut-out cover made of plastic (white or black);
- Hooks for attaching to desk made of 3 mm sheet metal, powder coated;
- Dimensions: 450x739/839, H=346 mm;
- Load capacity – 15 kg.

Drawers

- Facade made of 18 mm MFC (melamine) with 1 mm ABS edging;
- Box made of 16 mm MFC (melamine) with 1 mm ABS edging;
- Bottom made of 12 mm MFC (melamine);
- Convenient opening without handles;
- Soft closing function, lockable, full extension with hidden slides;
- Load capacity: top drawer – 15 kg, bottom drawer – 15 kg.

Metal box for cable management (2)

- Suitable for covering wire management through pedestals and for power blocks.
- Installed in pedestals' recess with wood screws;
- Removable covers attached with magnetic strip;
- 1 mm sheet metal, powder coated;
- Dimensions: 412x137, H=129 mm;
- Delivered unassembled.

Side metal drawers (3)

- Carcass – welded and bent sheet metal, powder coated;
- Underframe – welded 50x20 mm tube structure, powder coated;
- Holders – welded sheet metal, powder coated;
- Full extension ball bearing slides with roll-out prevention;
- Top insert – 9 mm PET felt insert;
- Fabric upholstered drawer box bottom insert;
- “Metal-to-metal” attachment to the desk structure;
- Load capacity – 25 kg (shelf – 15 kg, drawer – 10 kg).

Undermount metal drawers (4)

- Carcass – welded and bent sheet metal, powder coated;
- Holders – sheet metal, powder coated;
- Full extension ball bearing slides with roll-out prevention;
- Fabric upholstered drawer box bottom insert;
- Attached with wood screws to the desktop;
- Load capacity – 10 kg.

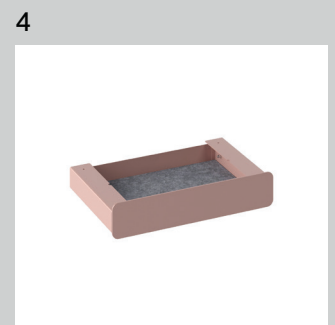
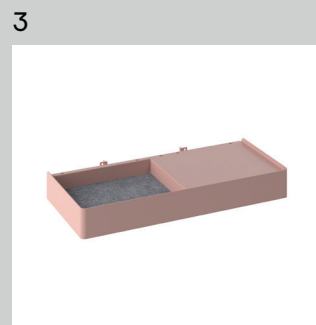
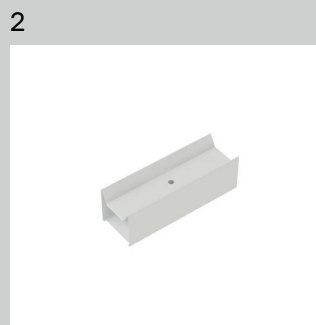
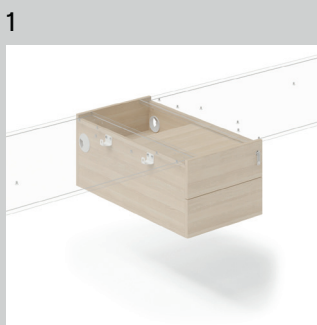

Shelves

Options

- Side shelf attached to the leg and desktop (1)
- Side shelf attached to the legs or leg and desktop (2)
- Side shelf for 2-desk bench attached to the legs (3)
- Set of side and curved shelves attached to the legs or leg and desktop (4)
- Curved shelf attached to the leg (5)
- Set of curved shelves attached to the leg (6)
- Rounded shelf attached to the leg (7)

Set of fittings

- Set of round tube, metal plate and connecting part; exact number of items in set depends on configuration;
- Tube – Ø40 mm, metal plate – Ø120x3 mm, connecting part – Ø40x19 mm CNC machined metal;
- Powder coated metal.

Shelf

- Metal sheet glued to MDF board;
- Top – straight or bent 3 mm metal sheet, powder coated;
- Bottom – 12 mm MDF, painted;
- 200/300 mm height from desktop depending on configuration;
- Load capacity: options 1, 2, 5, 7 - 10 kg, option 3 - 30 kg, option 6 - 15 kg.

Holder for shelves (8)

- Welded metal part, tube – Ø40 mm, 4 mm sheet metal;
- Powder coated metal.

1



2



3



4



5



6



7



8



Electrical specification

Power socket block ZZZ373 (1)

- 2 AC power sockets 220-240 V;
- Dimensions: 150x88x110 mm;
- Box and facade made of sheet metal, powder coated;
- Power socket standards: EU, FR, UK, CH;
- Mounting with clamping pad and plastic knob (no tools needed)
- Brackets designed to be attached to the desktop of 17-27 mm thickness;
- Hardwired power supply cable, approx. – 0,6 m, GST18i3 male end.

Power socket block ZZZ374 (2)

- 1 AC power socket 220-240 V;
- 1 Integrated USB fast charger (Type A+C, max 5A);
- Dimensions: 150x88x110 mm;
- Box and facade made of sheet metal, powder coated;
- Power socket standards: EU, FR, UK, CH;
- Mounting with clamping pad and plastic knob (no tools needed);
- Brackets designed to be attached to the desktop of 17-27 mm thickness;
- Hardwired power supply cable, approx. – 0,6 m, GST18i3 male end.

Power socket block ZZZ375 (3)

- 3 AC power sockets 220-240 V;
- Dimensions: 220x88x110 mm;
- Box and facade made of sheet metal, powder coated;
- Power socket standards: EU, FR, UK, CH;
- Mounting with clamping pad and plastic knob (no tools needed);
- Brackets designed to be attached to the desktop of 17-27 mm thickness;
- Hardwired power supply cable, approx. – 0,6 m, GST18i3 male end.

Power socket block ZZZ376 (4)

- 2 AC power sockets 220-240 V;
- 1 Integrated USB fast charger (Type A+C, max 5A);
- Dimensions: 220x88x110 mm;
- Box and facade made of sheet metal, powder coated;
- Power socket standards: EU, FR, UK, CH;
- Mounting with clamping pad and plastic knob (no tools needed);
- Brackets designed to be attached to the desktop of 17-27 mm thickness;
- Hardwired power supply cable, approx. – 0,6 m, GST18i3 male end.

Power socket block ZZZ377 (5)

- 2 AC power sockets 220-240 V;
- Dimensions: 150x88x110 mm;
- Box and facade made of sheet metal, powder coated;
- Power socket standards: EU, FR, UK, CH;
- Mounting with wood screws under desktop;
- Hardwired power supply cable, approx. – 0,6 m, GST18i3 male end.

Power socket block ZZZ378 (6)

- 1 AC power socket 220-240 V;
- 1 Integrated USB fast charger (Type A+C, max 5A);
- Dimensions: 150x88x110 mm;
- Box and facade made of sheet metal, powder coated;
- Power socket standards: EU, FR, UK, CH;
- Mounting with wood screws under desktop;
- Hardwired power supply cable, approx. – 0,6 m, GST18i3 male end.

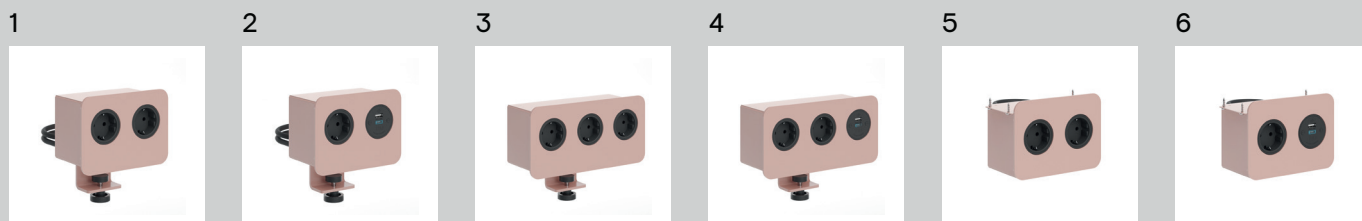

Range

Desks



Supplementary units

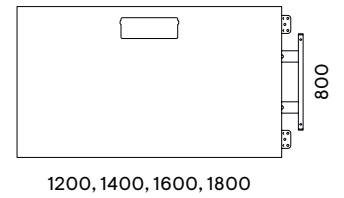
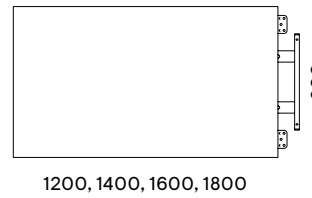
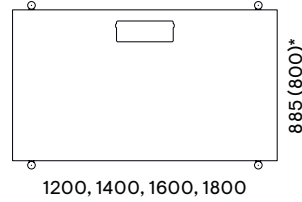
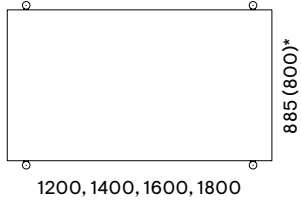
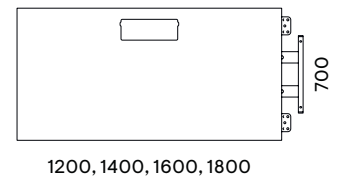
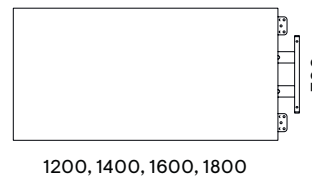
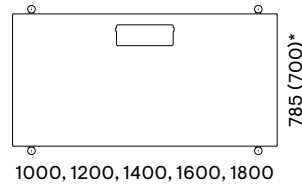
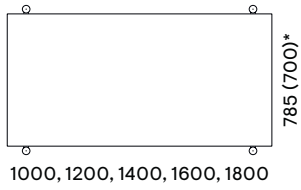

2-desk benches

Supplementary units

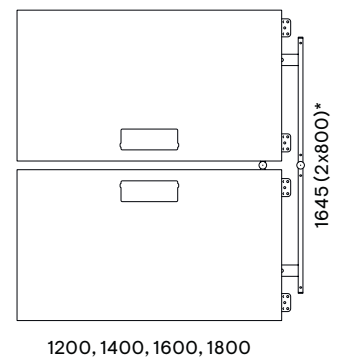
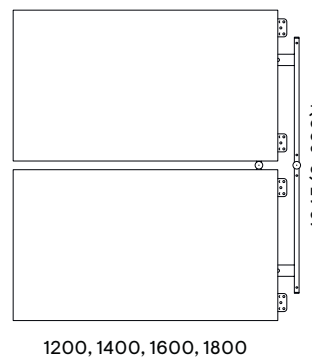
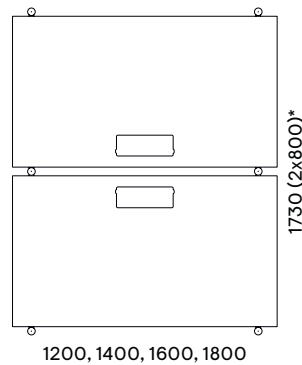
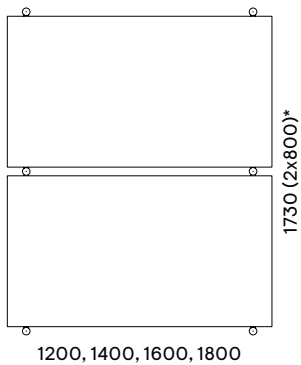
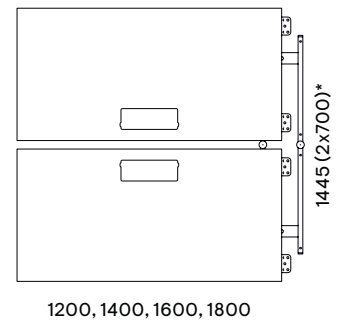
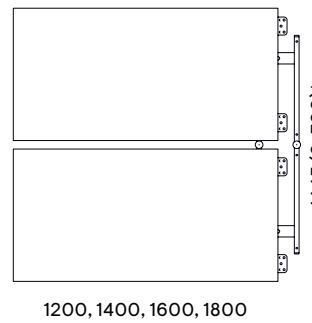
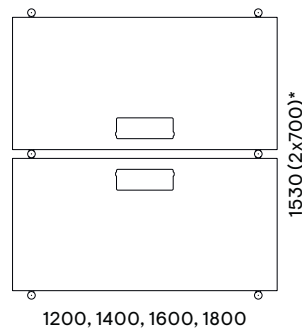
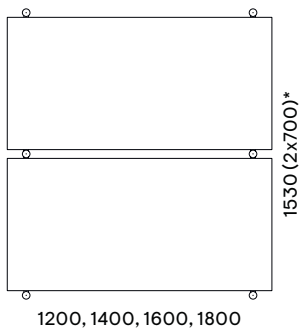

* Desktop depth

High extension table

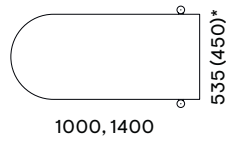

Top view of extension table in combination with desk

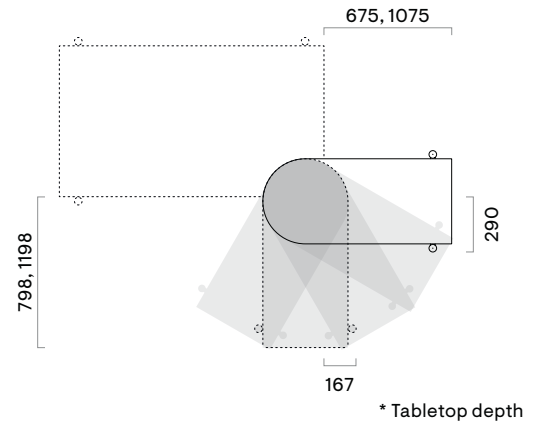

Storage



Top view of storage units in combination with desks

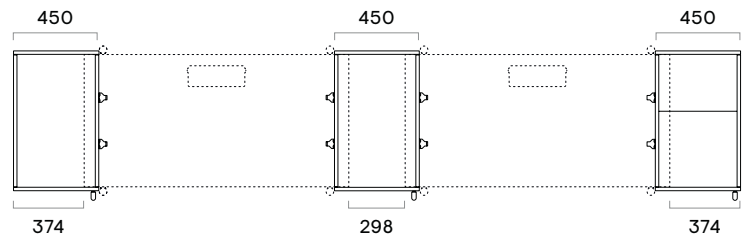

Towers

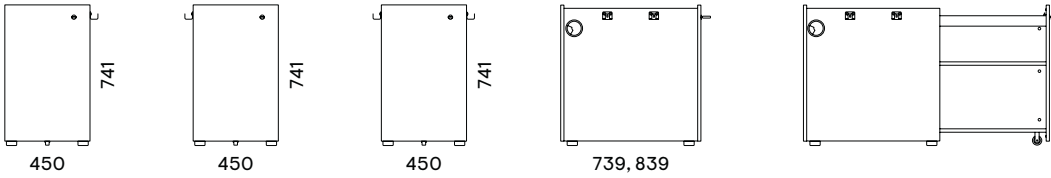

CPU Pedestals

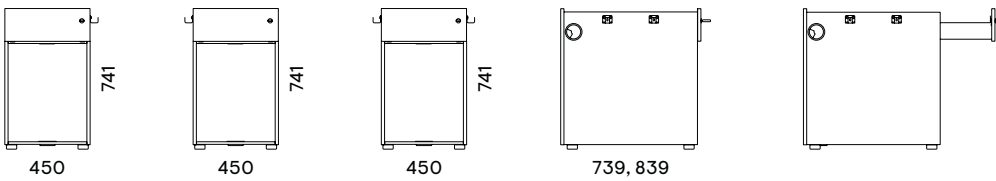

Pedestals

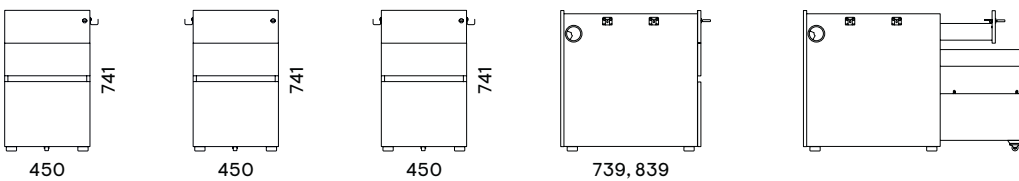

Hanging pedestals

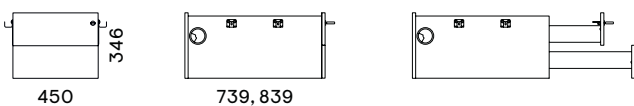

Accessories

Side metal drawers

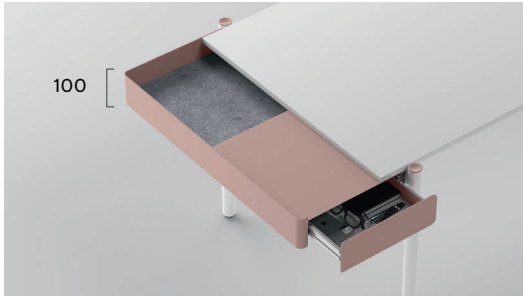

Top view of side metal drawers in combination with desks

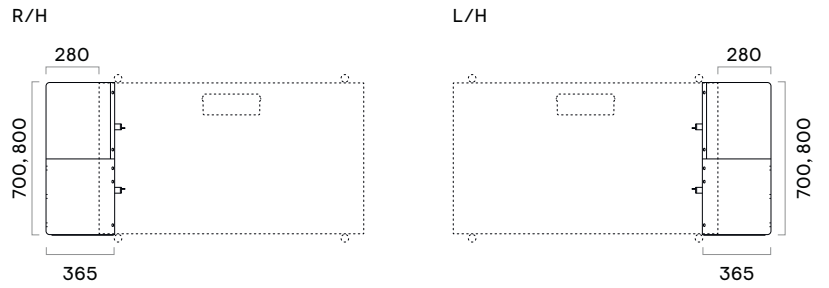

Undermount metal drawers



Top view of undermount metal drawers in combination with desks

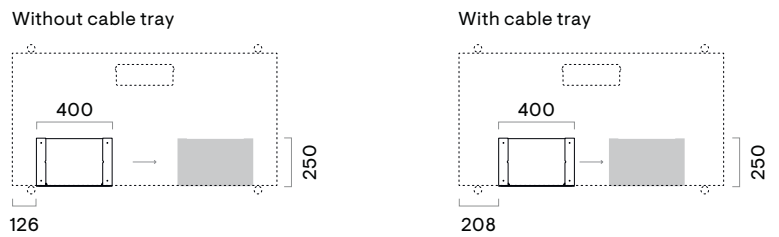

Side shelf attached to the leg and desktop

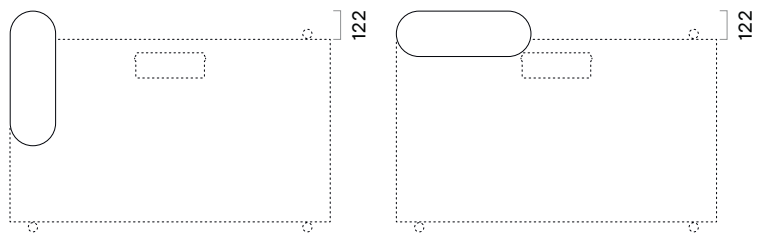
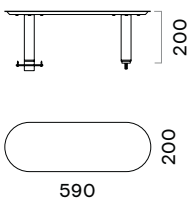

Side shelf attached to the legs or leg and desktop

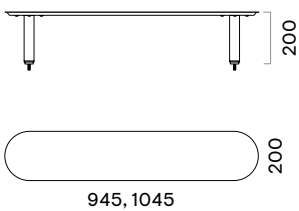

Shelf attached to the legs

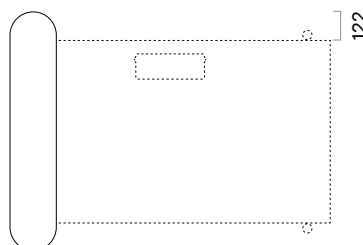

Shelf attached to the leg and desktop (DXZ020 must be ordered)

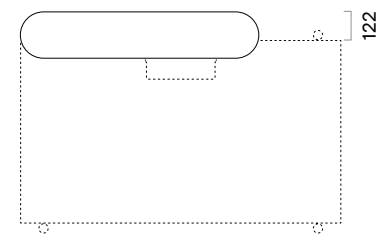

Side shelf for 2-desk bench attached to the legs

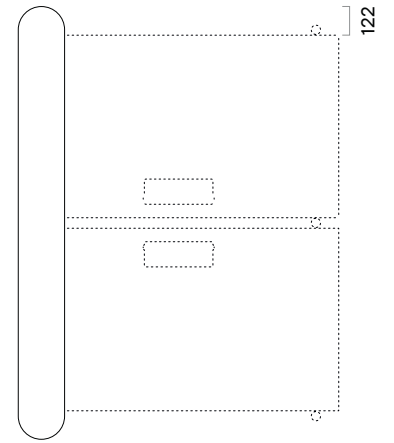
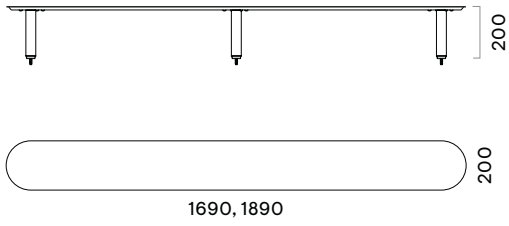

Set of side and curved shelves attached to the legs or leg and desktop

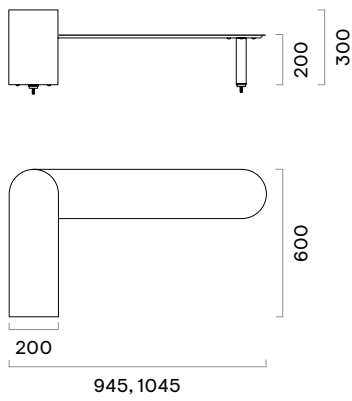

Set of shelves attached to the legs

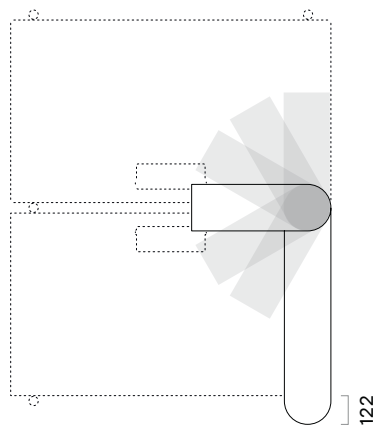

Set of shelves attached to the leg and desktop (DXZ020 must be ordered)

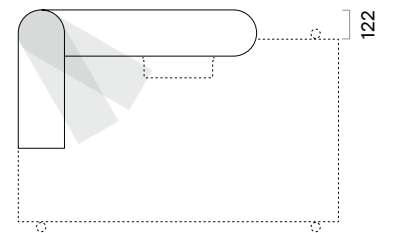

Curved shelf attached to the leg

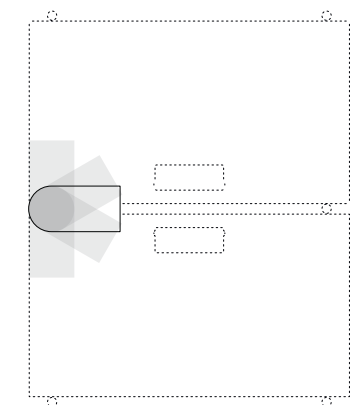
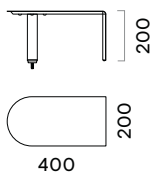

Curved shelf attached to the leg

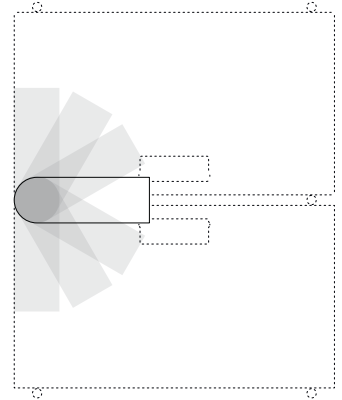
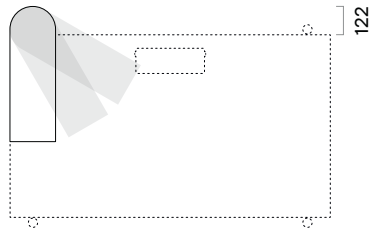
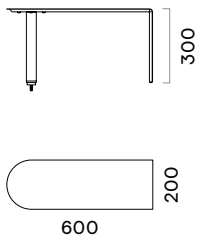

Set of curved shelves attached to the leg

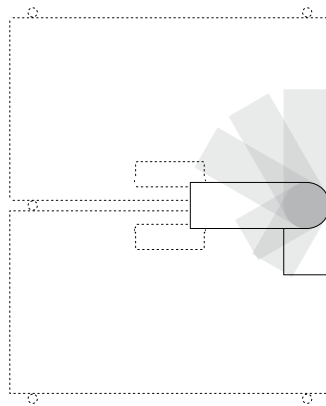
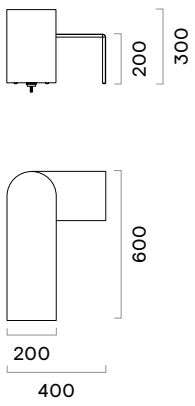

Rounded shelf attached to the leg

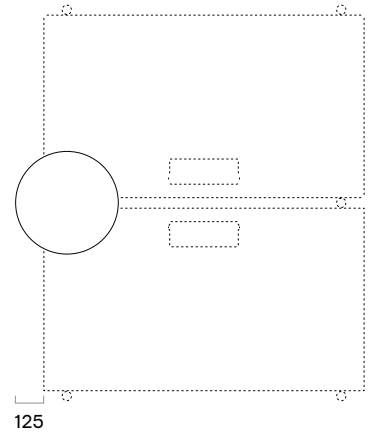
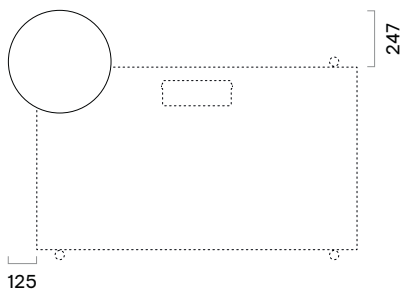
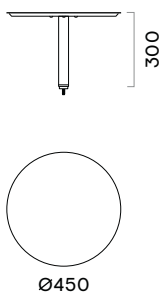

Power socket blocks

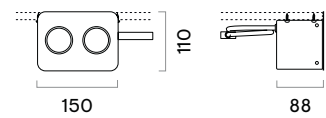
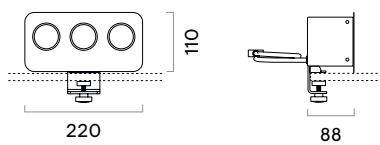
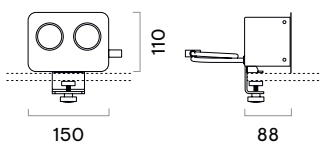

Additional information

- If you need to increase the number of workplaces, you can use maximum three supplementary units in one combination.



- High extension table can be rotated around its axis to create different zoning scenarios but it is not designed to be rotated on daily basis.

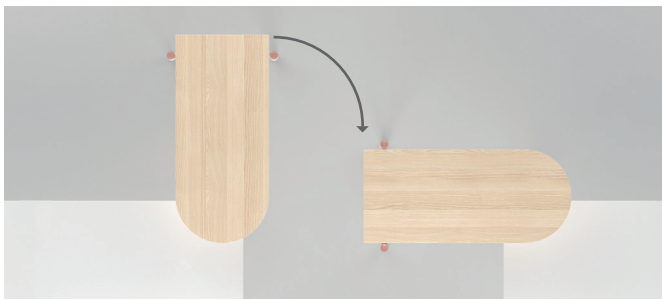

- Curved shelves can be rotated around its axis to create different scenarios but it is not designed to be rotated on daily basis and can leave marks on the desktop.

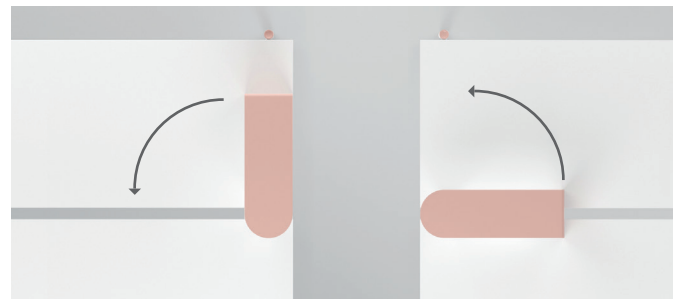

- High extension table and shelves with one connection point should be attached to the leg. Shelves cannot be fixed to the desktop only.

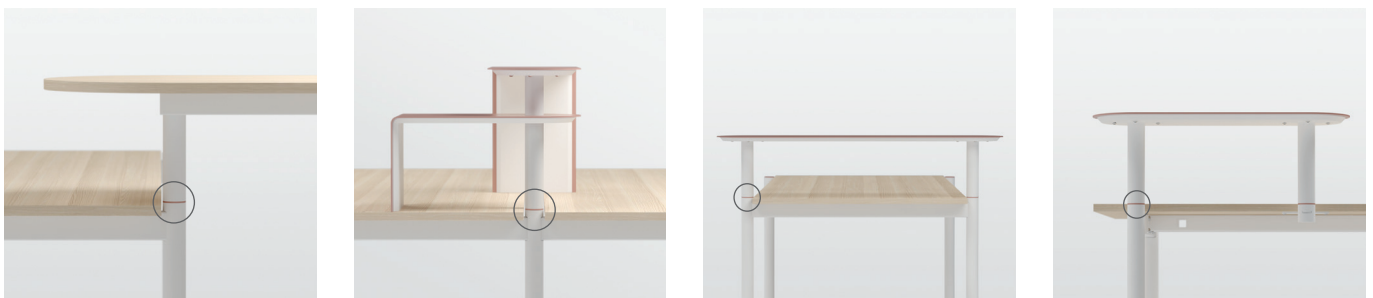

- In order to avoid tipping over of the desk, please do not use the maximum capacity of side drawer before the desk has items on it for counterbalance.

- Pedestals or towers are connected into the desk frame with special fittings.



- Metal box is suitable only for pedestals and could be fixed only in open space at the top.



- Accessories for towers – file drawer, drawers' box and metal shelf – can only be fixed in the bottom shelf.



- Information about available accessories for this range can be found in our product pricelists.

ZEDO PET

Technical information



Other documents available for this product

Technical information for ZEDO desks

Technical information for ZEDO conference & meeting tables

Ordering guidelines for ZEDO desks

Cable management guidelines for ZEDO desks

Warranty

See Warranty Statement

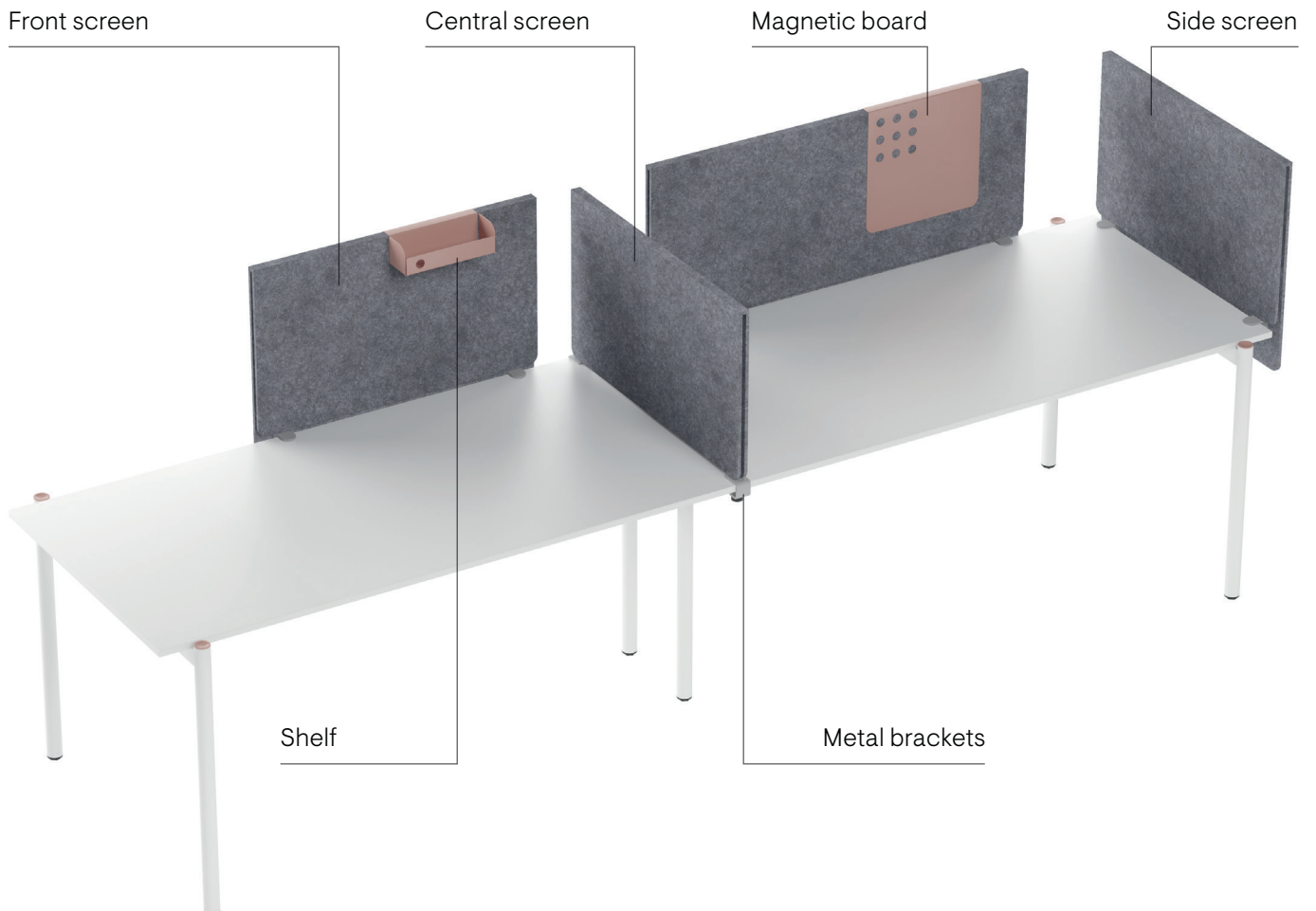

Technical information

Screen composition

- One PET fibre board (9 mm) cut, wrapped and glued to welded metal structure, made of 40x10 mm tubes;
- Powder coated metal;
- Solvent-free eco glues.

Metal brackets

- Bent 4 mm sheet metal clamping brackets;
- Powder coated metal;
- Galvanized clamping pad;
- Plastic knob with metal screw for tightening;
- Brackets designed to be attached to the desktop of 17-27 mm thickness.

Accessories

Shelf (1)

- Hanged on the screen, no tools required;
- 1,5 mm sheet metal, powder coated;
- Dimensions: 256x117, H=75 mm (outer), 253x84, H=74 mm (inner, box).

Magnetic board (2)

- Hanged on the screen, no tools required;
- Not suitable to be written on with markers;
- 1,5 mm sheet metal, powder coated;
- Dimensions: 350x32, H=350 mm.

1



2



Range

Screens

Front

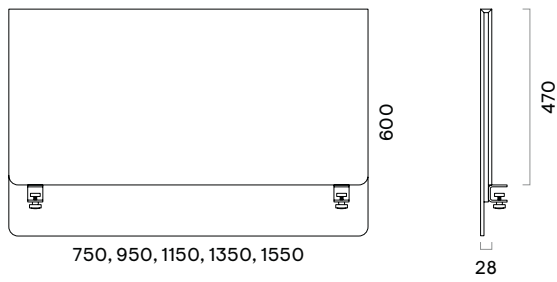

Side

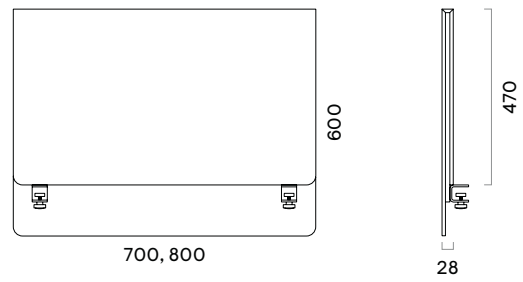

Central (for double benches)

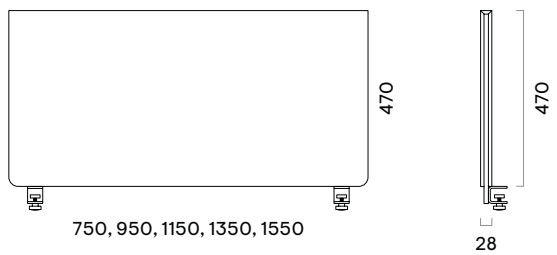

Central (for single row 2-desk benches)

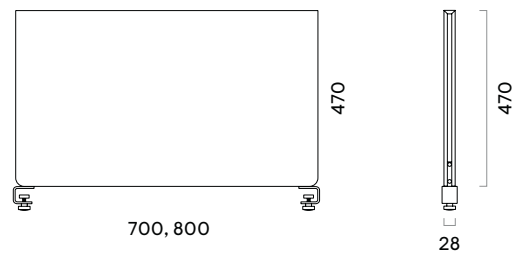

Accessories

Shelf

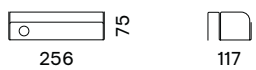

Magnetic board

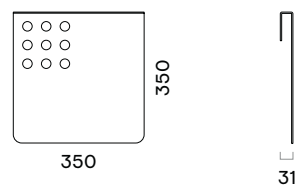

Additional information

- Screens are 450 mm shorter than the desks, as the space on the sides is meant for optional shelves.



- If you are not ordering optional shelves and would like the screen to cover the full length between the legs, please order a one size larger screen. E.g., for 1200 mm desk you should order a 1400 mm screen. For this reason, there are two screen options for the desk of 1800 mm length.

