



Conference tables L-L ine



MARO Office Furniture

For 30 years, we have been making sure that office work is comfortable and ergonomic. Our furniture demonstrates our professionalism and love for what we do. We are passionate about creating exquisite and functional things and that translates into a quest for new solutions that turn concepts into products at a higher and higher level. Using innovative engineering solutions, we strive for ensuring that our products are top-notch. Our quality has been proved by ISO 9001 and Geprüfte Sicherheit certificates. This is possible thanks to our technology park, where world-class techniques come together under one roof. As a responsible producer, we wish to minimize our ecological footprint and expect the same from our suppliers.

Our Machinery Park guarantees top quality and precision. Thanks to the investments in new techniques and constant search for unconventional solutions, we thrive all the time. We are aware of how valuable the human factor is, therefore some elements of our furniture are hand-made. Gluing the carcasses of curved counters is a job where the human has an advantage over the machine. However, where surgical precision and repeatability in short time are necessary, we take advantage of the latest technique. Wood processing center drills, mills and processes the edges with utmost precision. The quality of our furniture is based on hundreds of trials and tests, thanks to which we are certain that we are second to none



Conference tables L-Line

TRANSPORT

- Product delivered in boxes
- Self-assembly

WARRANTY

- 5-year MARO warranty

CERTIFICATES



MELAMINE PANEL BOARD CERTIFICATES



Sustainable development

Find out more about our activity.



maro.pl/firma/zrownowazony-rozwoj

L-Line

L-Line tables collection is a vast set of conference and occasional tables that can help to organize any meeting.

STRUCTURE

- Chipboard coated on both sides with melamine resin with increased durability - 1st class.
- Chipboard with reduced formaldehyde emission, E1 standard.
- Top finished with 2 mm thick ABS plastic edge with 3 mm radius.
- Top made of 25 mm thick board.



FRAME

- Self-supporting steel structure comprising of welded elements (legs forming the side or the center of the station) joined with beams whose number depends on the table depth.
- Column made of 65x65 mm profile with a square cross section.
- Depending on the top depth, the leg is equipped with one or two columns.
- Columns are joined with a foot.
- Powder-coated feet as standard. Chromium plated feet as an option with a surcharge.

HEIGHT

- Fixed height 740 mm, leveling feet +10 mm.

EQUIPMENT

- Cable management through a leg.
- Horizontal cable management: powder-coated fixed or fold-down cable channel or plastic cable clasp as an option with a surcharge.
- Vertical cable management: flexible cable channel or plastic spring as an option with a surcharge.
- Plastic cable outlets and netboxes as an option with a surcharge.



ADDITIONAL INFORMATION

- Colors according to MARO offer.
- Please specify the location of additional items such as extension modules and netboxes while ordering.

Conference table with rectangular top

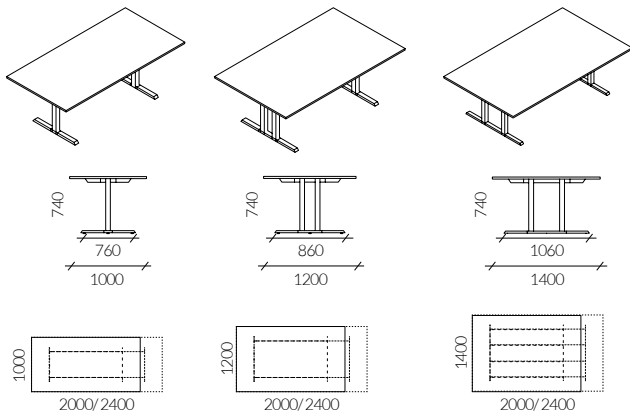

Conference table with barrel-shaped top

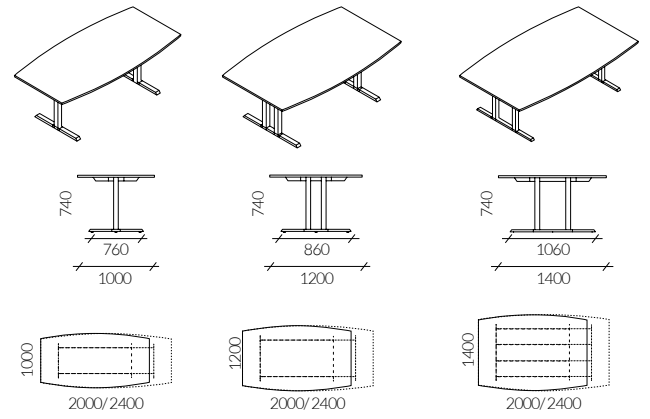

Two-piece conference table with rectangular top

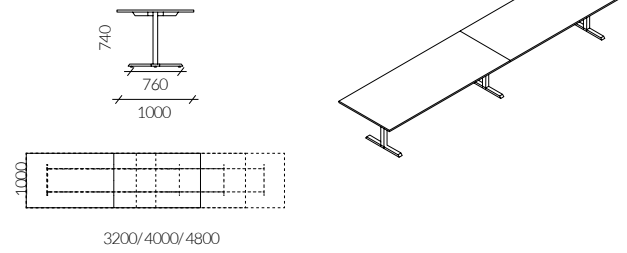

Two-piece conference table with barrel-shaped top

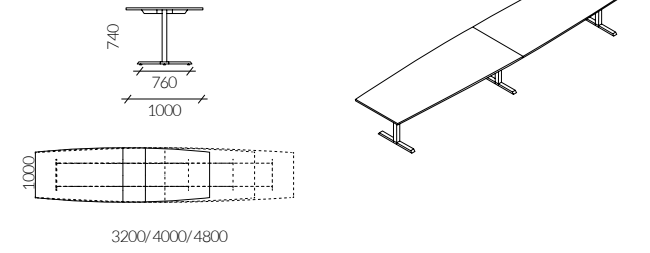

Two-piece conference table with rectangular top

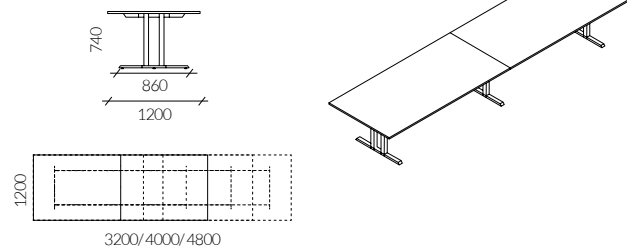

Two-piece conference table with barrel-shaped top

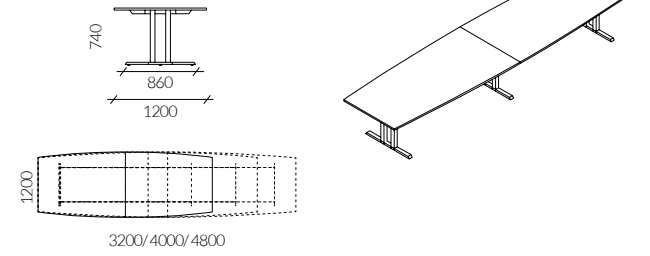

Two-piece conference table with barrel-shaped top

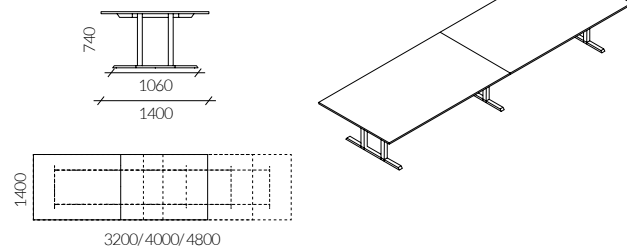

Two-piece conference table with barrel-shaped top

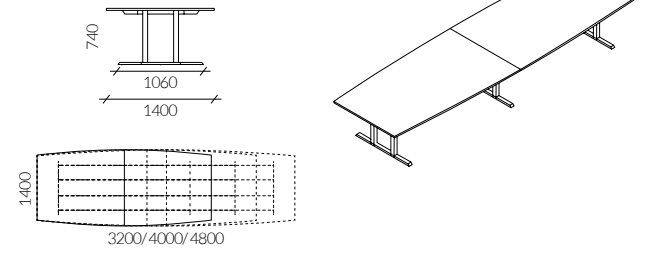

Stół konferencyjny kwadratowy

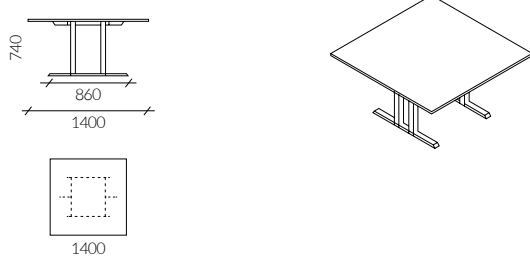

Square conference table

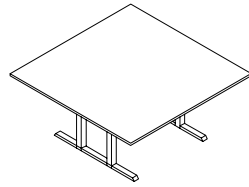
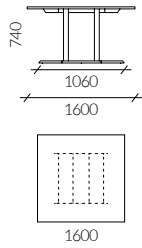

Extension module for conference tables

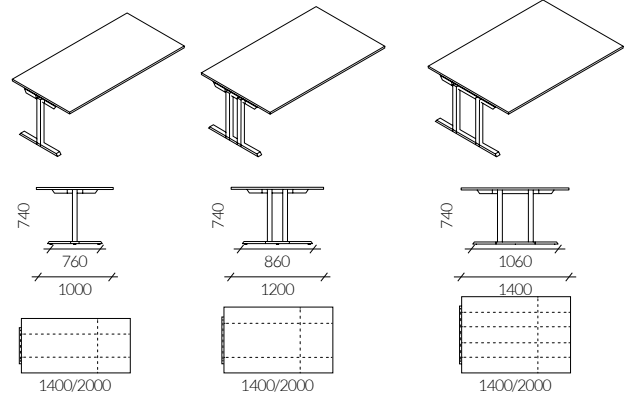

L-Line / Features

Graining

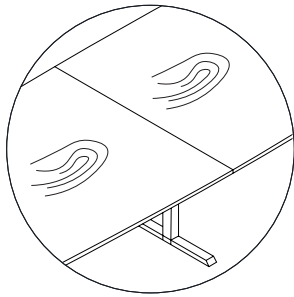

In two-piece tops continuous graining as standard. Minor displacement possible.

Foot

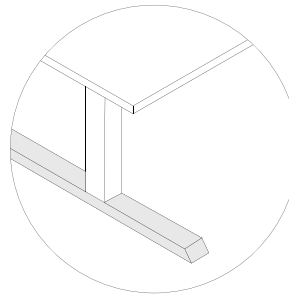

Powder-coated feet as standard. Chromium plated feet as an option with a surcharge.

Cables are managed through table legs as standard

L-Line / Accessories and surcharges

Cable management

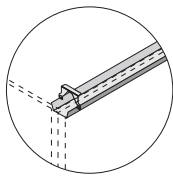

FIXED CABLE CHANNEL

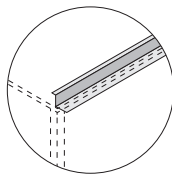

FOLD-DOWN CABLE CHANNEL

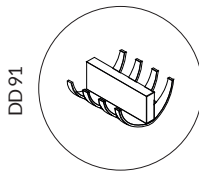

DD 91

COMB CABLE CLASP

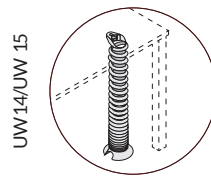

UW 14/UW 15

SPRING CABLE CHANNEL

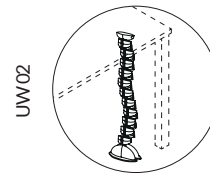

UW 02

FLEXIBLE CABLE CHANNEL

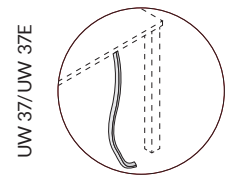

UW 37/ UW 37E

BRAIDED SLEEVE FOR CABLES

Cable outlets

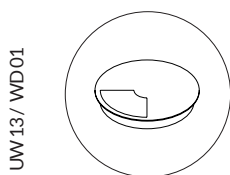

UW 13/ WD 01

ROUND CABLE OUTLET

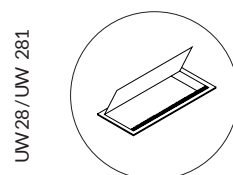

UW 28/ UW 281

ALUMINUM CABLE OUTLET

Netboxes

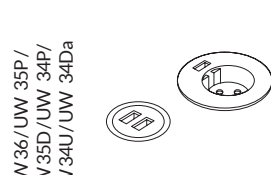

UW 36/ UW 35P / UW 35D/ UW 34P/ UW 34U/ UW 34Da

POWER CIRCLE S/M

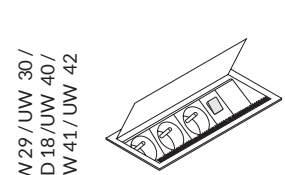

UW 29/ UW 30/ GD 18/ UW 40/ UW 41/ UW 42

NETBOX

L-Line / Colors

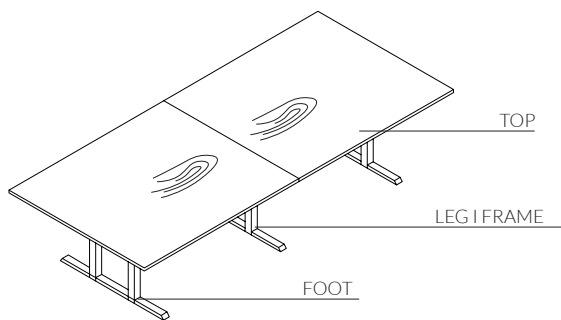
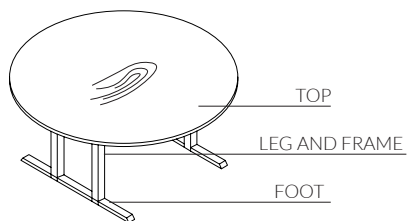

			Top	Foot	Leg and Frame
STANDARD	Melamine UNI	STD 1 White	•		
		STD 2 High Gloss White			
		STD 3 Gray	•		
		STD 4 Beige	•		
		STD 5 Norwegian Green	•		
		STD 6 Navy Blue	•		
		STD 7 Graphite	•		
		STD 8 Black	•		
	Melamine	STD 10 Acacia	•		
		STD 11 European Maple	•		
		STD 12 Napolitano Oak	•		
		STD 13 Gray Spruce	•		
		STD 14 American Oak	•		
		STD 15 Natural Oak	•		
		STD 16 Cherry Havana	•		
		STD 17 Walnut Brown	•		
		TREND*	Melamine	TRD 1 Blush	
TRD 2 Claret					
TRD 3 Dark Turquoise					
TRD 11 Stark Oak					
TRD 12 Flamed Oak					
STANDARD	Metal	M 02 White		•	•
		M 01 Aluminium		•	•
		M 03 Beige		•	•
		M 05 Graphite		•	•
		M 04 Black		•	•
TREND*	Metal	M 06 Sunny Beige		•	•
		M 09 Dirty Pink		•	•
		M 08 Ginger		•	•
		M 07 Faded Turquoise		•	•
ABS		Black			

			Top	Foot
PREMIUM**	HPL	FX1 Fenix Black	•	
		FX2 Fenix White	•	
	Solid wood	RW1 Lacquered Oak		
		RW2 Oiled Oak		
	Stone	ST 1 Nero Greco		
		ST 2 Noir Desir		
		ST 3 Bianco Venato		
	Veneer	VR 4 Burundi Mahogany		•
		VR 5 Brazilian Rosewood		•
		VR 6 Flader Oak		•
	Metal	Chrom		•

Melamine

① STANDARD



② TREND

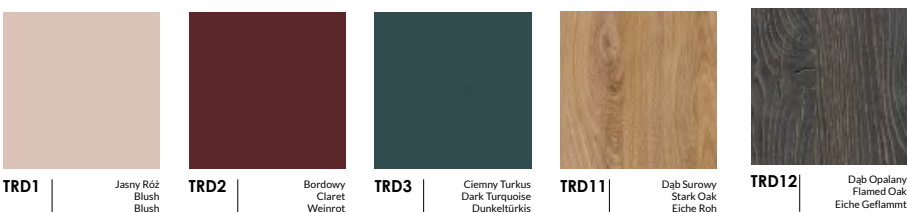

Metals

① STANDARD



② TREND

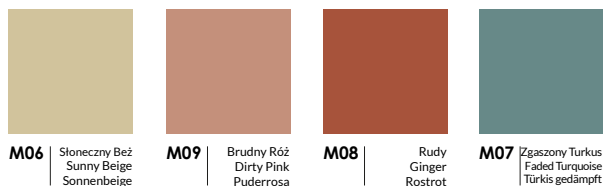

Fabrics

100% Polyester
100.000 Martindale cycles

① CALDO
Select by Lech

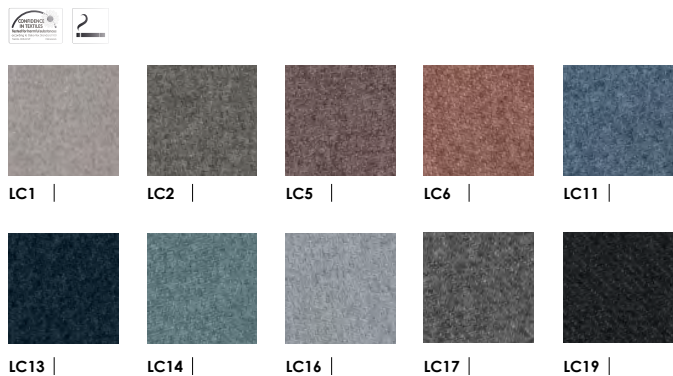

95% Virgin Wool, 5% Poliamid
100.000 Martindale cycles

② SYNERGY
Camira

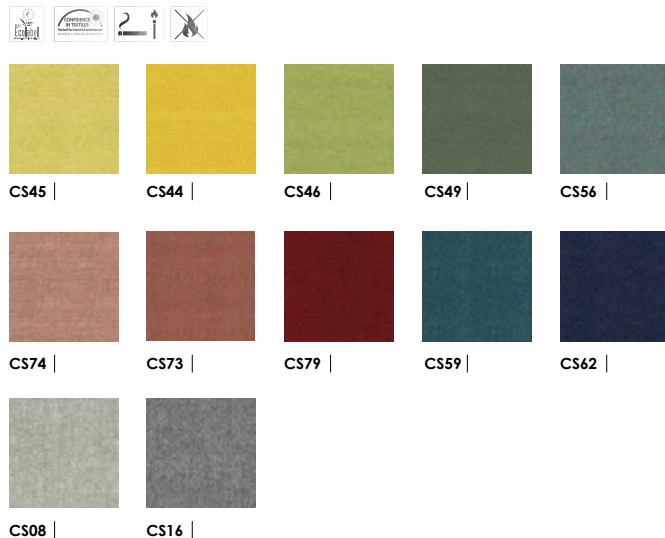

100% Recycled Polyester
67.000 Martindale cycles

① TERRA
Select by Lech



Information

You can find all our current materials online.

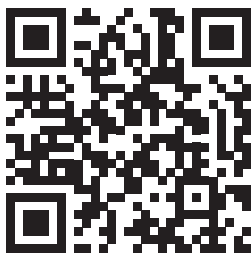

Visit our website maro.pl

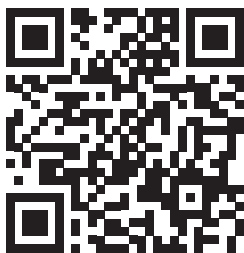

Find high quality photos and films to use in your materials
maro.cloud/photo

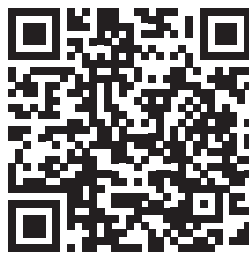

Find solids and catalogs
maro.pl/design-tools/pliki-do-pobrania



Order furniture online
shop.maro.pl



Fabryka Mebli Biurowych MARO Sp. z o. o.
PL 62-052 Komorniki, ul. Fabianowska 100

+48 61 890 00 00

maro@maro.pl

MARO.pl

Follow us and join t o MARO community

 [@maroofficefurniture](https://www.linkedin.com/company/maroofficefurniture)

 [@maroofficefurniture](https://www.facebook.com/maroofficefurniture)

 [@maroofficefurniture](https://www.instagram.com/maroofficefurniture)

 [@maroofficefurniture](https://www.youtube.com/maroofficefurniture)

Please place your orders for printed materials and color samples by e-mail t o marketing@maro.pl.

Illustrations presented in this publication are only illustrative and do not constitute any offer or guarantee of any form - it especially applies to presented color and furniture surfaces used by MARO Office Furniture Factory. Please contact MARO sp. z o. o. to obtain information on functions and configurations.

All presented data, especially photos, specifications, descriptions, drawings and technical parameters do not constitute an offer in legal terms of the Civil Code, are not binding and can be changed without prior notice. A Sales Contract contains bidding prices, equipment and specifications.

We reserve the right to make changes and mistakes. All the information in this price list is up-to-date on the publication date/accepting the material for publishing. The prices do not include VAT tax.

General Terms and Conditions of Sales and General Warranty and Complaint Terms and Conditions constitute an integral part of Sales Contracts.

The price list is valid from 01.07.2022 until further notice.